

CLEANROOM SYSTEMS

TECHNICS 08/20

CONTENT

LAMINAR FLOW UNITS	4
CLEANROOM KITS	9
PASS THROUGH BOXES	17

CLEANROOM SYSTEMS

LAMINAR FLOW UNITS

TECHNICS 08/20

OCTANORM 

CONTENT

LAMINAR FLOW UNITS

LAMINAR FLOW WORK BENCH 5

LAMINAR FLOW TABLE TOP 6

FAN FILTER UNITS 7

TECHNICAL INFORMATION

LAMINAR FLOW WORK BENCH

Laminar Flow Units

LAMINAR FLOW WORK BENCH

658 mm x 698 mm x 1764 mm



C 3020.90

aluminium

Anodized aluminium frame with clear acrylic glass, 4 mm, front hatch, tempered glass, 4 mm, with stop lock hinges. incl. desk top made from 12 mm board (stainless steel desk top at extra cost available) construction with adjustable feet Enviroco-Trion Fan-Filter-Unit (FFU), high efficiency particular Air (HEPA) filter: 99,99% efficient @ 0,3 micron; Air velocity: 0,45 m/s; air velocity can be controlled via 3-speed switch; 240 VDC / 115 VDC, 50 Hz, P = 255W

LAMINAR FLOW WORK BENCH

958 mm x 698 mm x 1764 mm



C 3021.90

aluminium

Anodized aluminium frame with clear acrylic glass, 4 mm, front hatch, tempered glass, 4 mm, with stop lock hinges. incl. desk top made from 12 mm board (stainless steel desk top at extra cost available) construction with adjustable feet Enviroco-Trion Fan-Filter-Unit (FFU), high efficiency particular Air (HEPA) filter: 99,99% efficient @ 0,3 micron; Air velocity: 0,45 m/s; air velocity can be controlled via 3-speed switch; 240 VDC / 115 VDC, 50 Hz, P = 255W

LAMINAR FLOW WORK BENCH

1258 mm x 698 mm x 1764 mm



C 3022.90

aluminium

Anodized aluminium frame with clear acrylic glass, 4 mm, front hatch, tempered glass, 4 mm, with stop lock hinges. incl. desk top made from 12 mm board (stainless steel desk top at extra cost available) construction with adjustable feet Enviroco-Trion Fan-Filter-Unit (FFU), high efficiency particular Air (HEPA) filter: 99,99% efficient @ 0,3 micron; Air velocity: 0,45 m/s; air velocity can be controlled via 3-speed switch; 240 VDC / 115 VDC, 50 Hz, P = 255W

LAMINAR FLOW TABLE TOP

Laminar Flow Units

LAMINAR FLOW TABLE TOP MODULE

658 mm x 698 mm x 994 mm



C 3010.90

aluminium

Anodized aluminium frame with clear acrylic glass, 4 mm, front hatch, tempered glass, 4 mm, with stop lock hinges. Envirco-Trion Fan-Filter-Unit (FFU), high efficiency particular Air (HEPA) filter: 99,99% efficient @ 0,3 micron; Air velocity: 0,45 m/s; air velocity can be controlled via 3-speed switch; 240 VDC / 115 VDC, 50 Hz, P = 255 W

LAMINAR FLOW TABLE TOP MODULE

958 mm x 698 mm x 994 mm



C 3011.90

aluminium

Anodized aluminium frame with clear acrylic glass, 4 mm, front hatch, tempered glass, 4 mm, with stop lock hinges. Envirco-Trion Fan-Filter-Unit (FFU), high efficiency particular Air (HEPA) filter: 99,99% efficient @ 0,3 micron; Air velocity: 0,45 m/s; air velocity can be controlled via 3-speed switch; 240 VDC / 115 VDC, 50 Hz, P = 255 W

1258 mm x 698 mm x 994 mm



C 3012.90

aluminium

Anodized aluminium frame with clear acrylic glass, 4 mm, front hatch, tempered glass, 4 mm, with stop lock hinges. Envirco-Trion Fan-Filter-Unit (FFU), high efficiency particular Air (HEPA) filter: 99,99% efficient @ 0,3 micron; Air velocity: 0,45 m/s; air velocity can be controlled via 3-speed switch; 240 VDC / 115 VDC, 50 Hz, P = 255 W

FAN FILTER UNITS

Laminar Flow Units

FAN FILTER UNIT

1185 mm x 585 mm

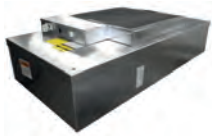

C 2217.90

steel

steel Enviroco-Trion Fan-Filter-Unit (FFU), high efficiency particular Air (HEPA) filter: 99,99% efficient @ 0,3 micron; Air velocity: 0,45 m/s; air velocity can be controlled via 3-speed switch; 240 VDC / 115 VDC, 50 Hz, P = 255 W
30.25 kg

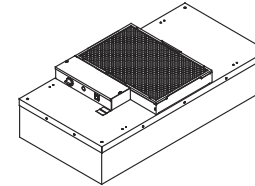

COLD APPLIANCE CABLE



C 2217/01.90

plastic

2 m, 10A/250V
0.25 kg

CLEANROOM SYSTEMS

CLEANROOM KITS

TECHNICS 08/20

OCTANORM ®

CONTENT

CLEANROOM KITS

CLEANROOM KITS 10

WALL ELEMENTS 13

CEILING ELEMENTS 15

TECHNICAL INFORMATION

CLEANROOM KITS

Cleanroom Kits

CLEANROOM KIT

Kit No.1
(l/w/h) 1968 x 2624 x 2340 mm

C 2510.01

aluminium
Cleanroom kit out of pre-fabricated partition and ceiling elements for the do-it-yourself assembly.
1 x ceiling element for FFU C 2215, 4 x corner element C 2115, 1 x wall element with PVC strip curtain C 2120, 2 x wall element, small C 2100, 3 x wall element C 2110, 2 x ceiling element C 2200 excl. FFU
205.5 kg

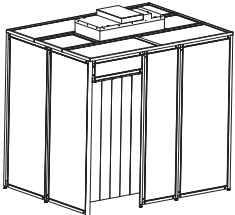

CLEANROOM KIT

Kit No.2
(l/w/h) 2319 x 2624 x 2340 mm

C 2520.01

aluminium
Cleanroom kit out of pre-fabricated partition and ceiling elements for the do-it-yourself assembly.
1 x ceiling element for FFU C 2215, 4 x corner element C 2115, 1 x wall element with PVC strip curtain C 2120, 6 x wall element, small C 2100, 1 x wall element C 2110, 2 x ceiling element C 2200, 1 x ceiling element C 2205, excl. FFU

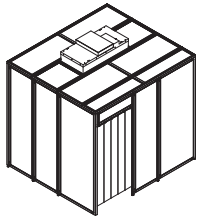

CLEANROOM KIT

Kit No.3
(l/w/h) 2624 x 2624 x 2340 mm

C 2530.01

aluminium
Cleanroom kit out of pre-fabricated partition and ceiling elements for the do-it-yourself assembly.
1 x ceiling element for FFU C 2215, 4 x corner element C 2115, 1 x wall element with PVC strip curtain C 2120, 4 x wall element, small C 2100, 3 x wall element C 2110, 3 x ceiling element C 2200 excl. FFU

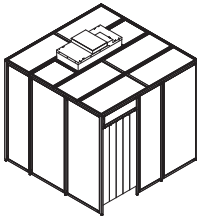

CLEANROOM KITS

Cleanroom Kits

CLEANROOM KIT

Kit No.4
(l/w/h) 2929 x 2624 x 2340 mm

C 2540.01

aluminium
Cleanroom kit out of pre-fabricated partition and ceiling elements for the do-it-yourself assembly
1 x ceiling element for FFU C 2215, 4 x corner element C 2115, 1 x wall element with PVC strip curtain C 2120, 2 x wall element, small C 2100, 5 x wall element C 2110, 1 x ceiling element C 2210, 2 x ceiling element C 2200 excl. FFU
254.66 kg

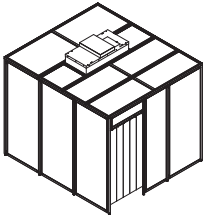

CLEANROOM KIT

Kit No.5
(l/w/h) 3280 x 2624 x 2340 mm

C 2550.01

aluminium
Cleanroom kit out of pre-fabricated partition and ceiling elements for the do-it-yourself assembly.
1 x ceiling element for FFU C 2215, 4 x corner element C 2115, 1 x wall element with PVC strip curtain C 2120, 6 x wall element, small C 2100, 3 x wall element C 2110, 4 x ceiling element C 2200 excl. FFU

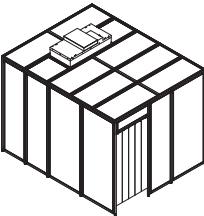

CLEANROOM KIT

Kit No.6
(l/w/h) 3585 x 2624 x 2340 mm

C 2560.01

aluminium
Cleanroom kit out of pre-fabricated partition and ceiling elements for the do-it-yourself assembly.
1 x ceiling element for FFU C 2215, 4 x corner element C 2115, 1 x wall element with PVC strip curtain C 2120, 4 x wall element, small C 2100, 5 x wall element C 2110, 3 x ceiling element C 2200, 1 x ceiling element, wide C 2210, excl. FFU

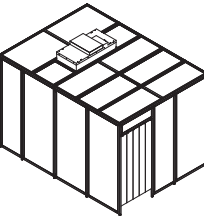

CLEANROOM KITS

Cleanroom Kits

CLEANROOM KIT

Kit No.7

(l/w/h) 3890 x 2624 x 2340 m

C 2570.01

aluminium

Cleanroom kit out of pre-fabricated partition and ceiling elements for the do-it-yourself assembly.

1 x ceiling element for FFU 4 x corner element C 2115, 1 x wall element with PVC strip curtain C 2120, 2 x wall element, small C 2100, 7 x wall element C 2110, 2 x ceiling element, wide C 2210, 2 x ceiling element C 2200, excl.

FFU

313.03 kg

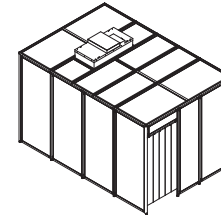

WALL ELEMENTS

Cleanroom Kits

WALL ELEMENT
Corner element
small

C 2105.01

Aluminium/acrylic glass
aluminium frame with acrylic panel

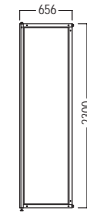

WALL ELEMENT
size 961 x 2300 mm

C 2110.01

Aluminium/acrylic glass
aluminium with acrylic panel

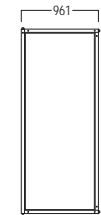

WALL ELEMENT
Corner element
size 961 x 2300 mm

C 2115.01

Aluminium/acrylic glass
aluminium frame with acrylic panel

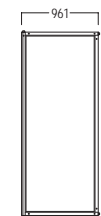

WALL ELEMENTS

Cleanroom Kits

WALL ELEMENT
with curtain
size 961 x 2300 mm

C 2120.01

Aluminium/acrylic glass
aluminium frame with PVC strip curtain

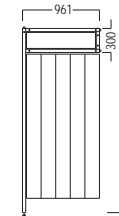

CEILING ELEMENTS

Cleanroom Kits

CEILING ELEMENT
size 656 x 2624 mm

C 2200.01

aluminium
aluminium frame with aluminium composite panel

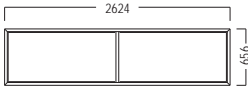

CEILING ELEMENT
small
size 351 x 2624 mm

C 2205.01

aluminium
aluminium frame with aluminium composite panel

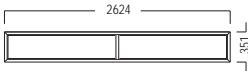

CEILING ELEMENT
wide
size 961 x 2624 mm

C 2210.01

aluminium
aluminium frame with aluminium composite panel

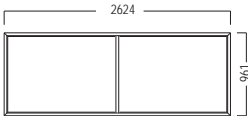

CEILING ELEMENTS

Cleanroom Kits

CEILING ELEMENT
for FFU
size 656 x 2624 mm

C 2215.01

aluminium
aluminium frame with aluminium composite panel excl.
FFU

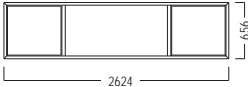

CEILING ELEMENT
for lighting
size 656 x 2624 mm

C 2220.01

aluminium
aluminium frame with aluminium composite panel excl.
Ceiling integrated light

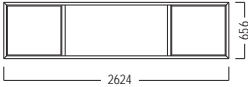

PASS THROUGH BOXES

Pass through boxes

PASS TROUGH BOX

560 mm x 560 mm x 560 mm



C 3200.80

aluminium

with two all-glass doors, 6 mm tempered glass, electrical interlock system, frame out of aluminium profiles, anodized E6EV1 and zinc diecast corner connection, Corpus and work surface out of shock-proof and abrasion-resistant moulded fiber board, color standard white
16.9 kg

! Scope of supply and services does not include the electronic connection and must be provided on site.

PASS TROUGH BOX

760 mm x 760 mm x 760 mm



C 3210.90

aluminium

with two all-glass doors, 6 mm tempered glass, electrical interlock system, frame out of aluminium profiles, anodized E6EV1 and zinc diecast corner connection, Corpus and work surface out of shock-proof and abrasion-resistant moulded fiber board, color standard white

! Scope of supply and services does not include the electronic connection and must be provided on site.

PASS TROUGH BOX

Powder coated RAL 9010
790 x 790 x 600 mm,



C 3300.90

aluminium

Pass through box for usage in cleanrooms with classification A-D by GMP, clear passage frame 660 x 660 x 500 mm, Corpus out of steel sheet, powder-coated RAL 9010, interior planking out of stainless steel 1.4301, without further processing, 2 single doors with single glazing, 4 mm tempered glass, one-side flush-mounted and sealed according to cleanroom standard.
92.5 kg

! Scope of supply and services does not include the electronic connection and must be provided on site.

PASS THROUGH BOXES

Pass through boxes

PASS THROUGH BOX

Stainless steel
790 x 790 x 600 mm



C 3310.44

aluminium

Pass through box for usage in cleanrooms with classification A-D by GMP, clear passage frame 660 x 660 x 500 mm, Corpus out of stainless steel sheet, 1.4301 brushed, interior planking out of stainless steel 1.4301, without further processing, 2 single doors with single glazing, 4 mm tempered glass, installed one side being flush
92.5 kg

! Scope of supply and services does not include the electronic connection and must be provided on site.

CONTENT

WALL SYSTEMS ELECTRONICS	22
CEILING SYSTEM ELECTRONICS	50
DOOR SYSTEMS ELECTRONICS	70

CLEANROOM SYSTEMS

WALL SYSTEMS ELECTRONICS

TECHNICS 08/20

OCTANORM 

40 X 40 MM

Wall Systems electronics

SQUARE EXTRUSION
with 4 system grooves
5000 mm long

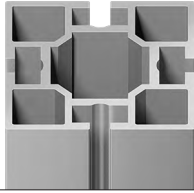

M 1000.01

aluminium
for connection on 4 sides, tension lock Z 961/8 can be mounted in 2 positions, 5000 mm long
5.782 kg

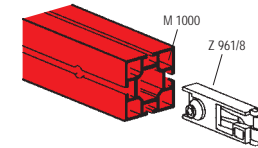
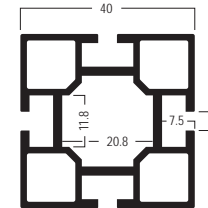

SQUARE EXTRUSION
with 4 system grooves
6000 mm long

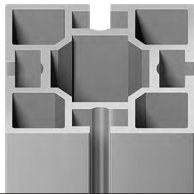

M 1001.01

aluminium
for connection on 4 sides, tension lock Z 961/8 can be mounted in 2 positions, 6000 mm long
6.97 kg

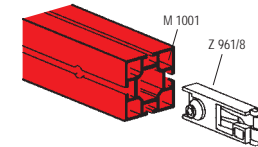
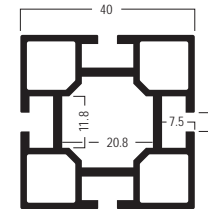

END CAP
for uprights
40 mm



M 1014.35

plastic
for all square extrusions 40 mm
0.004 kg

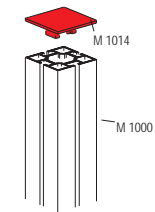
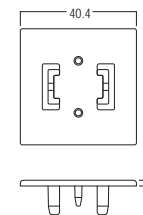

40 X 40 MM

Wall Systems electronics

SQUARE EXTRUSION
with 2 system grooves
5000 mm long

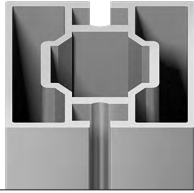

M 1002.01

aluminium
tension lock Z 961/8 can be mounted in 2 positions, 5000 mm long
5.554 kg

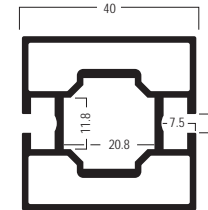

SQUARE EXTRUSION
with 2 system grooves
6000 mm long

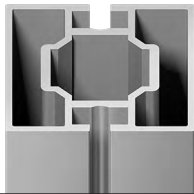

M 1003.01

aluminium
tension lock Z 961/8 can be mounted in 2 positions, 6000 mm long
6.922 kg

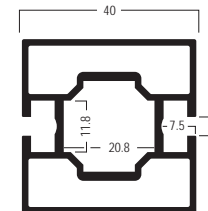

SQUARE EXTRUSION
with 3 system grooves
40 mm

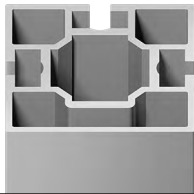

M 1005.01

aluminium
for connection on 3 sides, tension lock Z 961/8 can be mounted in 2 positions, groove depth 7 mm, 6000 mm long
6.664 kg

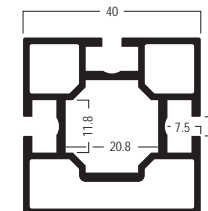

40 X 40 MM

Wall Systems electronics

SQUARE EXTRUSION with 2 system grooves for corners

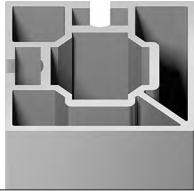

M 1007.01

aluminium
for connection on 2 sides, tension lock Z 961/8 can be mounted in 2 positions, 6000 mm long
7.174 kg

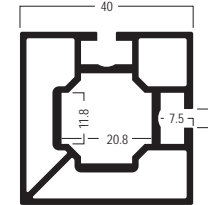

EXTRUSION 135° angle 40 mm

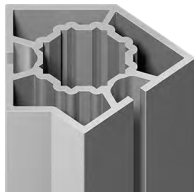

M 1009.01

aluminium
for connection on 2 sides, tension lock Z 961/8 can be mounted in 2 positions, 6000 mm long
7.818 kg

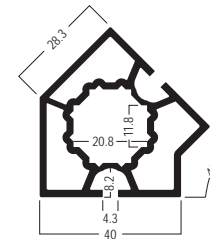

ADJUSTABLE FOOT

C 430.00

zinc die cast/steel
for upright extrusions M 1001, M 1005, M 1007
0.131 kg

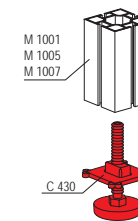
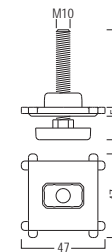

ADJUSTABLE FOOT for upright M 1009 135° corner



C 441.37

steel, zinc plated
incl. 2 x set screw M 1075/20 (M4), for exterior corner
extrusion M 1009
0.158 kg

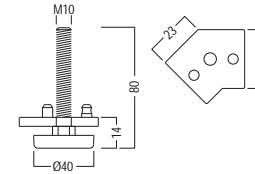

END CAP 13 mm dia.



M 1491.35

plastic, light grey
similar to RAL 7035, to cover drill holes with a diameter of
8 mm

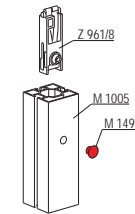
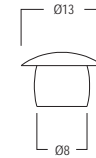

BEAM EXTRUSION

C 120.01.80

aluminium
2 system grooves, transition glass/glass
6000 mm long
7.09 kg

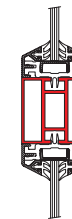
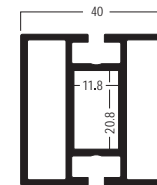

UPRIGHT EXTRUSION

C 124.01

aluminium
aluminium 2 system grooves, with higher bending 4500 mm long
5.82 kg



UPRIGHT EXTRUSION

C 125.01

aluminium
2 system grooves, with higher bending 6000 mm long
7.572 kg



ADJUSTABLE FOOT

C 431.00

steel/zinc die cast
for upright extrusions C 124 and C 125
0.128 kg

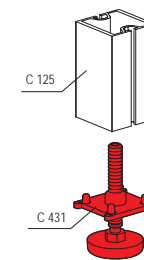
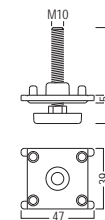

FOOT PLATE

C 455.33

plastic
black, for adjustable foot C 431
0.008 kg

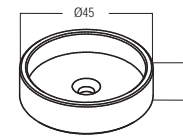

BEAM EXTRUSION

C 105.01.80

aluminium

1 system groove, for wall constructions between glass and panel or as lower wall ending
6000 mm long
9.26 kg

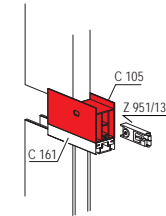
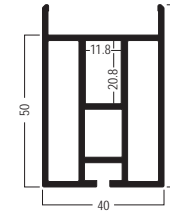

BEAM EXTRUSION

C 110.01.80

aluminium

for wall constructions between glass and panel or as upper and lower wall ending
6000 mm long
7.568 kg

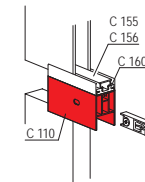
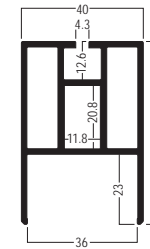

END CAP

C 420.35

plastic

to cover the punching hole

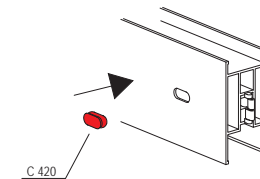
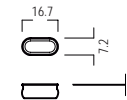

70 X 40 MM

Wall Systems electronics

BEAM EXTRUSION

C 115.01.80

aluminium
1 system groove, adjustment extrusion door frame
6000 mm long
9.029 kg

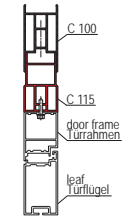
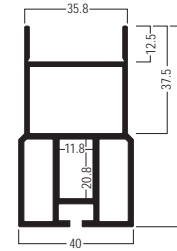

80 X 40 MM

Wall Systems electronics

BEAM EXTRUSION

C 100.01.80

aluminium

for wall constructions between panel and panel or as upper wall ending 6000 mm long
9.98 kg

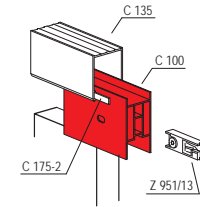
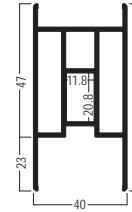

100 X 40 MM

Wall Systems electronics

RECTANGULAR EXTRUSION

40 x 100 mm
6000 mm long

M 1029.01

aluminium
6000 mm long
11.88 kg

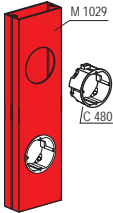
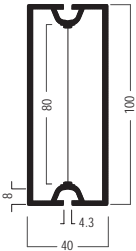

ADJUSTABLE FOOT

support for beams on both sides

C 446.37

steel, zinc plated
for upright extrusion M 1029 with support for beams on both sides
0.27 kg

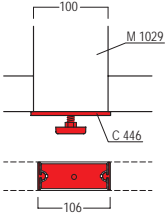
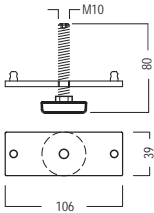

ADJUSTABLE FOOT

support for beams on one side

C 447.37

steel, zinc plated
for upright extrusion M 1029 with support for beams on one side
0.264 kg

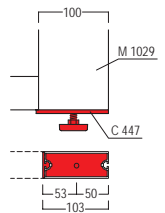
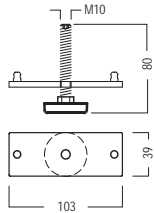

100 X 40 MM

Wall Systems electronics

ADAPTOR
for M 1029
with 2 tension locks Z 961/13

M 1128.01

aluminium, matt anodized, silver
incl. 2 tension locks Z 961/13 and fixing accessories M5,
for mounting in rectangular extrusion M 1029
0.241 kg

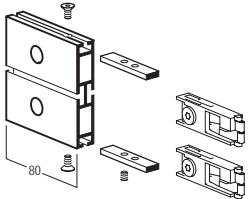

END PLATE
3 mm thick

M 1083.21

steel
for rectangular extrusion M 1029
0.099 kg

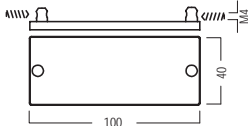

U-CHANNEL EXTRUSION

Wall Systems electronics

U-CHANNEL EXTRUSION
for floor

C 130.01

aluminium
6000 mm long
5.33 kg

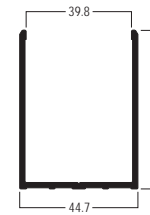

SPACING EXTRUSIONS

Wall Systems electronics

SPACING EXTRUSION

C 151.01

aluminium
for 60 mm systems for triple glazing, for 3 and 6 mm
glass/panel thickness 6000 mm long
2.284 kg

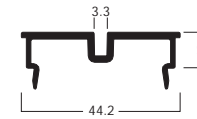

SPACING EXTRUSION

C 153.01

aluminium
for triple glazing, for 3 and 6 mm glass/panel thickness
6000 mm long
1.69 kg

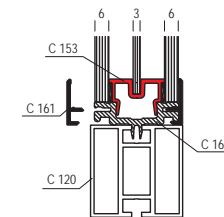
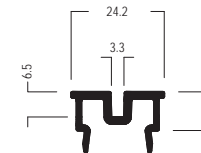

SPACING EXTRUSION

C 155.01

aluminium
for 5 and 6 mm glass/panel thickness 6000 mm long
1.242 kg

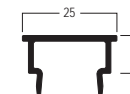

SPACING EXTRUSIONS

Wall Systems electronics

SPACING EXTRUSION

C 157.01

aluminium
for 60 mm systems 6000 mm long
1.333 kg

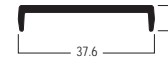

SPACING EXTRUSION

C 158.01

aluminium
6000 mm long
0.79 kg

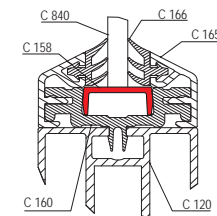
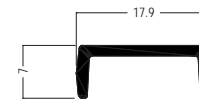

ADAPTOR EXTRUSION

C 159.35

plastic
for 60 mm systems 6000 mm long
2.035 kg



ADAPTOR EXTRUSION

C 160.35

plastic
6000 mm long
1.61 kg

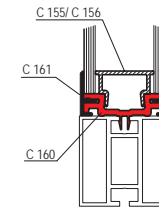
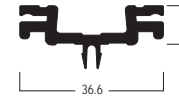

SUSPENSION EXTRUSION

C 161.01

aluminium
for glass or panels up to 6 mm thickness 6000 mm long
0.75 kg

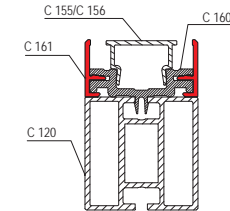

SUSPENSION EXTRUSION

C 162.01

aluminium
for panels with 36 mm thickness 6000 mm long
0.75 kg

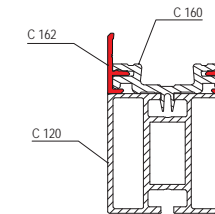
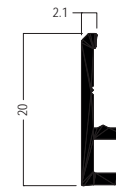

GLASS PANEL RETAINER

C 163.01

aluminium
for 35.6 mm thick insulating glass panels 6000 mm long
0.806 kg

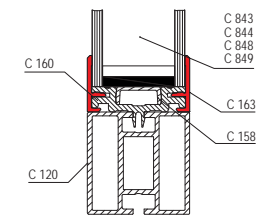
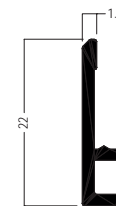

RETAINER EXTRUSIONS

Wall Systems electronics

GLASS PANEL RETAINER

C 165.01

aluminium
for centered installation of panels/glass 5-8 mm thick 6000 mm long
1.08 kg

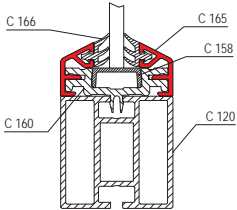
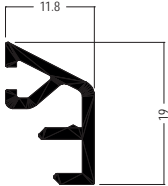

GASKET

C 166.35

PVC, soft
50 m long
2.425 kg

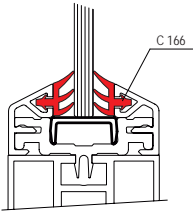

GASKET

C 167.33

rubber
Gasket for panels 16 mm in combination with extrusion C 165
0.37 kg



SUSPENSION EXTRUSION

6000 mm long

C 169.01

aluminium
for panels with 16 mm thickness centered installation
1.236 kg

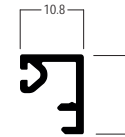

SUSPENSION EXTRUSION

C 170.01

aluminium
vertical installation, for one-sided flush installation of
panels/glass 5 and 6 mm thick 6000 mm long
1.38 kg

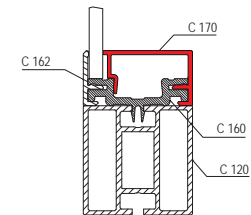
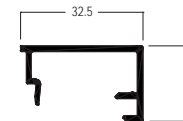

SUSPENSION EXTRUSION

C 171.01

aluminium
horizontal installation, for one-sided flush installation of
panels/glass 5 and 6 mm thick 6000 mm long
1.64 kg

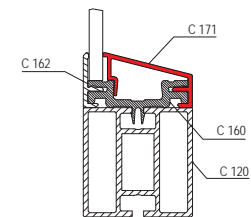
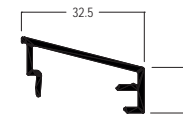

RETAINER EXTRUSIONS

Wall Systems electronics

GASKET

C 175-2.90

plastic
self adhesive 10 m long
0.04 kg



GASKET

C 175-3.90

plastic
black self adhesive, 10 m long
0.048 kg



GASKET

C 175-5.90

plastic
plastic self adhesive 10 m long
0.071 kg



RETAINER EXTRUSIONS

Wall Systems electronics

COVER PLATE

C 408.01

aluminium
for floor u-channel extrusion C 130
0.053 kg

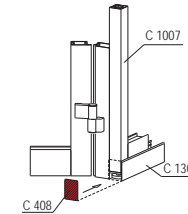
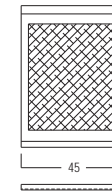

CAVITY WALL BOX

installation depth 35 mm



C 480.90

plastic
68 mm dia.
0.019 kg

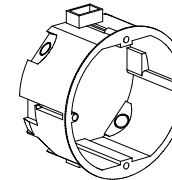

EXTRUSION

C 601.01

aluminium
3 system grooves usable as ceiling beam, upright extrusion
and beam extrusion 6000 mm long
8.694 kg

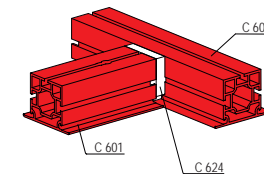
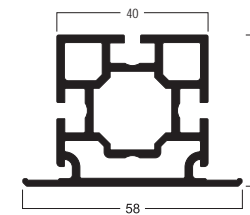

RETAINER EXTRUSIONS

Wall Systems electronics

EXTRUSION

C 701.01

aluminium

3 system grooves usable as ceiling beam, upright extrusion and beam extrusion 6000 mm long
8.88 kg

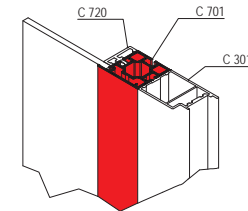
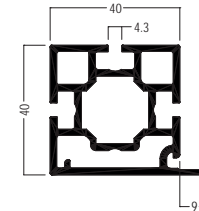

EXTRUSION

C 606.01

aluminium

4 system grooves usable as ceiling beam, upright extrusion, and beam extrusion 6000 mm long
9.489 kg

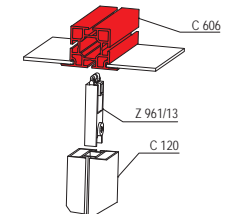
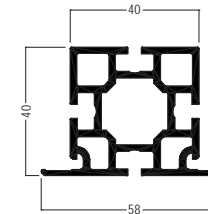

CEILING EXTRUSION

C 608.01

aluminium

with opening for mounting LED lights, to be used as ceiling light channel in combination with cover extrusion C 636
6000 mm long
7.32 kg

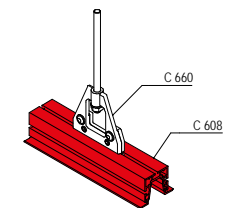
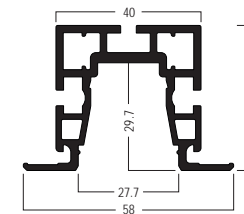

RETAINER EXTRUSIONS

Wall Systems electronics

EXTRUSION

C 604.01

aluminium

4 system grooves usable as ceiling beam, upright extrusion and beam extrusion 6000 mm long
9.15 kg

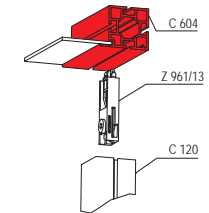
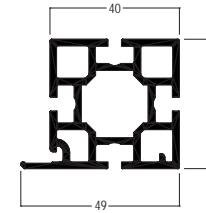

UPRIGHT EXTRUSION

Interior corner

C 703.01

aluminium

2 system grooves 6000 mm long
8.66 kg

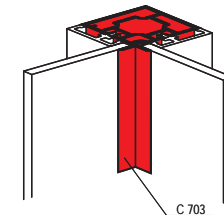
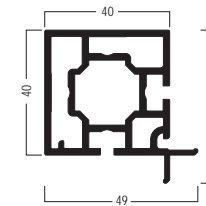

UPRIGHT EXTRUSION

Exterior corner

C 705.01

aluminium

2 system grooves 6000 mm long
8.94 kg

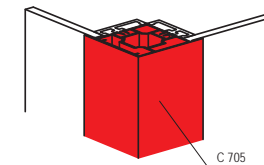
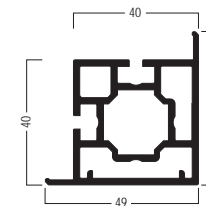

WALL CONNECTING EXTRUSION

C 715.01

aluminium
1 system groove, for panels 6 mm 6000 mm long
3.048 kg

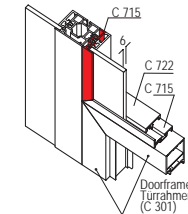

SUSPENSION EXTRUSION

C 722.01

aluminium
for one sided flush installation of panels/glass 6 mm thick
6000 mm long
1.83 kg

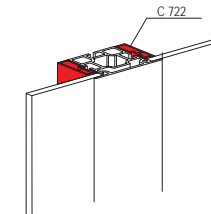
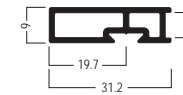

CLIP



E 470/C.30

plastic
to put into extrusion E 470/N, E 471/N recommendation:
4 pieces / running meter for extrusion C 722,
2 pieces / running meter for extrusion W 910

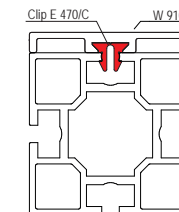
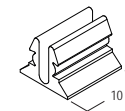

EXTRUSION CONNECTOR

C 725.35

plastic, semi-hard
for connection of 2 aluminium extrusions in parallel
alignment 5950 mm long
0.26 kg

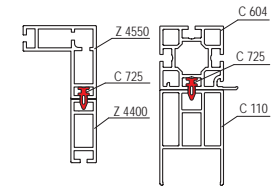
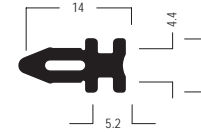

PANELS

Wall Systems electronics

ALUMINIUM SANDWICH PANEL
composite panel 4 mm

C 826-4.75

Aluminium/plastic
4.68 kg

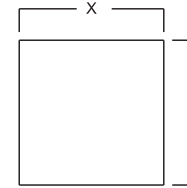

GRILLE

Wall Systems electronics

EXPANDED METAL

C 818.80

steel
for air grille in "light walls"
1.738 kg

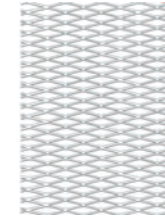

EXPANDED METAL with polyester mat size 928 x 612 mm

C 819.80

steel
powder coated mesh size, 20 x 15 mm, 1.7 mm thick incl.
filtermat G4
1.58 kg

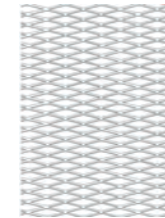

AIR GRILLE basic 19%

C 821.80

aluminium/steel
for mounting into wall panel and doors with cutout 918 x
600 mm approx. 19% free surface area
6.704 kg

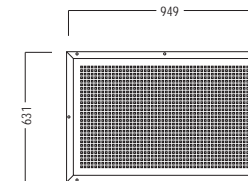

GRILLE

Wall Systems electronics

AIR GRILLE
basic 44%

C 823.80

aluminium/steel
for mounting into wall panel and doors with cutout 918 x 600 mm approx. 44% free surface area
3.8 kg

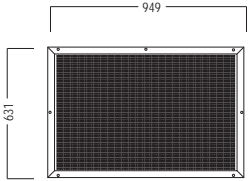

AIR GRILLE
adjustable

C 825.80

aluminium/steel
for mounting into wall panel and doors with cutout 0-19%, 918 x 600 mm penetrability adjustable
8.51 kg

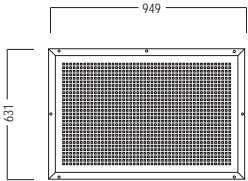

FRAME EXTRUSION

C 875.01

aluminium
for return air grill and glassing 6000 mm long
2.218 kg



CEILING SYSTEMS ELECTRONIC

Ceiling System electronics

EXTRUSION

C 601.01

aluminium
3 system grooves usable as ceiling beam, upright extrusion and beam extrusion 6000 mm long
8.694 kg

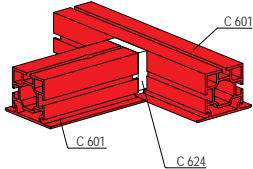
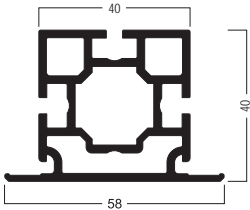

EXTRUSION

C 701.01

aluminium
3 system grooves usable as ceiling beam, upright extrusion and beam extrusion 6000 mm long
8.88 kg

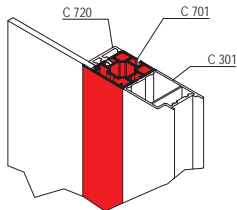
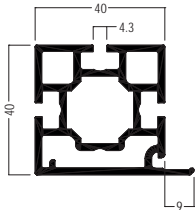

EXTRUSION

C 606.01

aluminium
4 system grooves usable as ceiling beam, upright extrusion, and beam extrusion 6000 mm long
9.489 kg

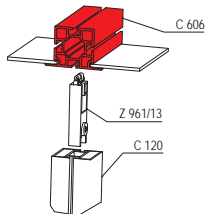
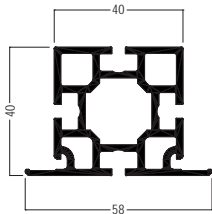

EXTRUSION

C 604.01

aluminium

4 system grooves usable as ceiling beam, upright extrusion and beam extrusion 6000 mm long
9.15 kg

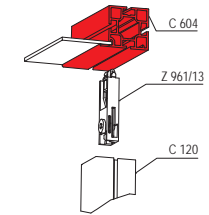
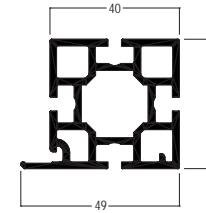

CLIP

6 mm thick

C 730.33

plastic

plastic for fixing wall and ceiling elements
0.003 kg

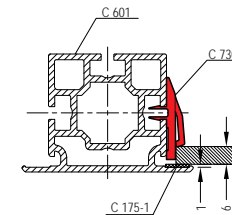
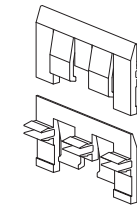

GASKET

C 174-2.90

plastic

self-adhesive 40 m long
0.037 kg



GASKET

C 174-3.90

plastic
self-adhesive 25 m long
0.025 kg

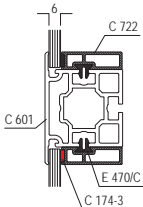

GASKET

60 m x 8 mm, self-adhesive



C 175-1.30

plastic
1 mm PE-foam
0.05 kg

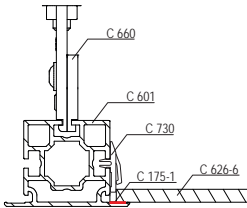

SUPPORTING EDGE

C 612.01

aluminium
6000 mm long
1.11 kg

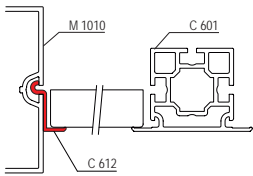
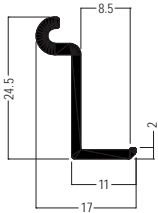

SUPPORTING EDGE

wide

C 613.01

aluminium
6000 mm long
1.818 kg

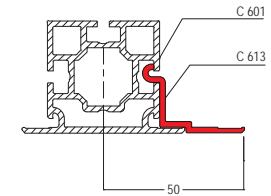
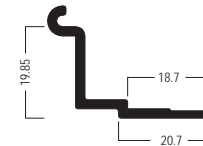

SPRING

C 620.90

spring steel
stainless for fixing ceiling elements C 880 and C 881
0.012 kg

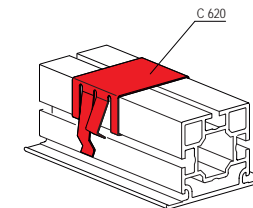
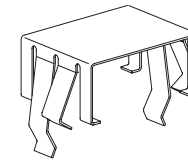

TENSION LOCK

with plastic adaptor C 625

C 624.00

steel/plastic
for ceiling extrusion C 601, C 604, C 606, C 701, C 710
0.062 kg

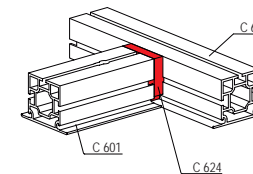
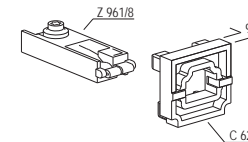
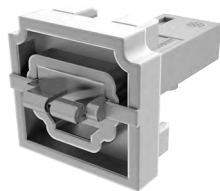

H-EXTRUSION

C 630.01

aluminium
6000 mm long
1.279 kg

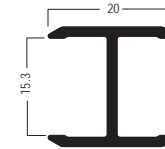

MOUNTING RAIL 2000 mm



C 640-2.37

steel, zinc plated
2000 mm long
2.168 kg

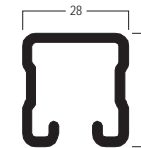

MOUNTING RAIL 3000 mm



C 640-3.37

steel, zinc plated
3000 mm long
3.72 kg

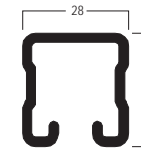

CEILING SYSTEMS ELECTRONIC

Ceiling System electronics

MOUNTING RAIL
3000 mm



C 641-3.37

steel, zinc plated
3000 mm long
5.94 kg

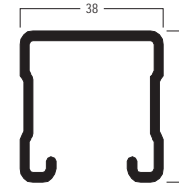

MOUNTING RAIL
6000 mm



C 641-6.37

steel, zinc plated
6000 mm long
11.8 kg

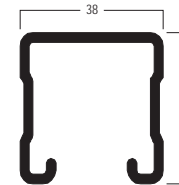

MOUNTING RAIL



C 642-4.37

steel, zinc plated
4000 mm long
15.4 kg

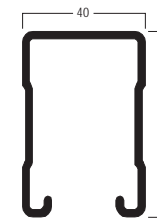

COVER PLUG

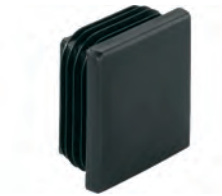

C 640-AK.33

plastic
plastic, for mounting rail 28/30
0.006 kg



COVER PLUG

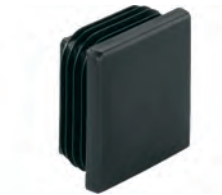

C 641-AK.90

plastic
for mounting rail 38/40
0.011 kg

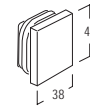

LOCATION CLAMP



C 640-HK.37

steel, zinc plated
for mounting rail 27/18 and 28/30
0.03 kg

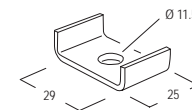

LOCATION CLAMP



C 641-HK.37

steel, zinc plated
for mounting rail C 641-3 and C 641-6
0.065 kg

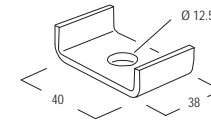

LOCATION CLAMP



C 642-HK.90

steel, zinc plated
for mounting rail 40/60
0.083 kg

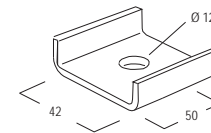

ANCHOR BOLT

max. usable length 10 mm



C 645.37

steel, zinc plated
M8
0.035 kg

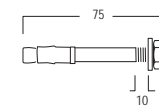

HEXAGONAL CONNECTOR



C 646.37

steel, zinc plated
0.014 kg

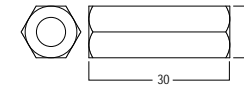

SLIDING NUT 50 mm long



C 640-SM.37

steel, zinc plated
M8
0.026 kg

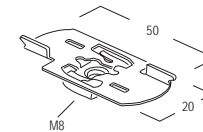

SLIDING NUT 39 mm long



C 641-SM.37

steel, zinc plated
M8
0.018 kg

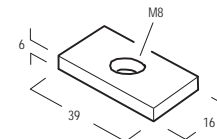

ANCHOR BOLT

max. usable length 30 mm

C 640-AB.37

steel, zinc plated
M8
0.05 kg

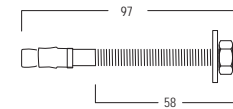

ANCHOR BOLT

max. usable length 50 mm

C 641-AB.37

steel, zinc plated
M8
0.044 kg

CLAMP HANGER

for thread rod M8



C 648-M8.37

steel
0.146 kg

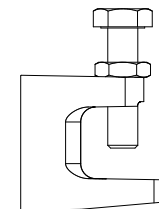

CEILING SYSTEMS ELECTRONIC

Ceiling System electronics

FIXING ANGLE
94 x 40 x 60 mm



C 651.37

sheet metal
0.18 kg

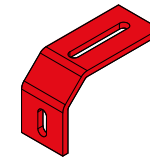
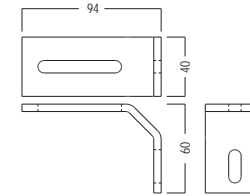

FIXING ANGLE

C 652.37

steel
0.152 kg

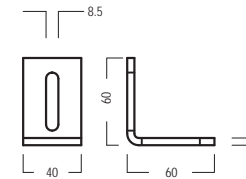

HAMMERHEAD SCREW

C 653.37

steel
M5
0.006 kg

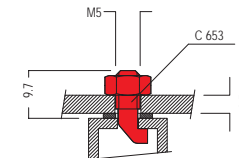

CEILING SYSTEMS ELECTRONIC

Ceiling System electronics

THREAD ROD

M8
1000 mm



C 661.37

steel, zinc plated
1000 mm long
0.279 kg

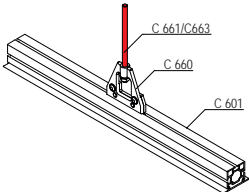
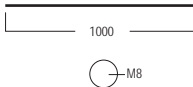

THREAD ROD

M8
2000 mm



C 662.37

steel, zinc plated
0.619 kg

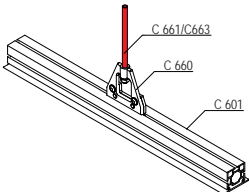
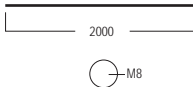

THREAD ROD

M8
3000 mm



C 663.37

steel, zinc plated
0.921 kg

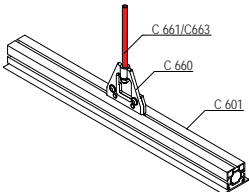
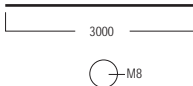

FIXING-SET



C 660.37

zinc die cast/steel
consisting of Part A und B, for mounting to system groove
4,3 mm incl. 2 screws M 1557/20 and 2 set screws
M 1435/70, for suspension of cleanroom ceiling weith
thread rod M8 for loads up to 300 Kg
0.232 kg

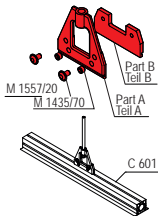
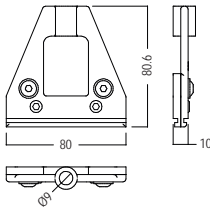

1 for loads up to 300 Kg

SCREW



C 666.37

steel
0.005 kg



SCREW



C 693-4825.37

steel, zinc plated
drilling screw with truss head ZEBRA Pias
0.002 kg



CEILING SYSTEMS ELECTRONIC

Ceiling System electronics

PEG



C 668.35

plastic



CEILING EXTRUSION

C 670.01

aluminium
anodized 2400 mm long
0.555 kg

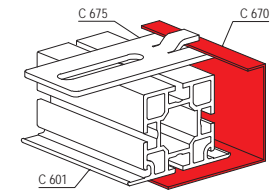
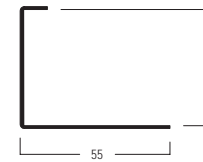

CEILING CLAMP

C 675.37

steel, zinc plated
together with M 1472 Hammerhead screw
0.066 kg

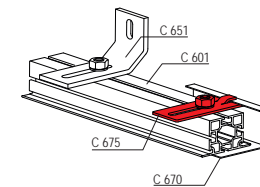
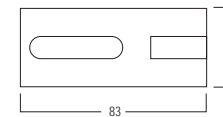

WASHER

M8



C 677.37

steel, zinc plated
0.003 kg

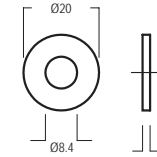

WASHER

M4



C 679.37

steel, zinc plated

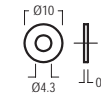

BUTTON HEAD SOCKET SCREW WITH FLANGE

M5 x 10 mm



C 827.37

steel, zinc plated



L-EXTRUSION

6000 mm long



C 680.01

aluminium
60 x 40 mm
2.958 kg

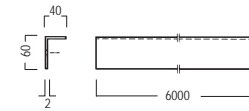

LIGHT

1175 mm long

C 966.90

plastic
case white with acrylic diffusor, control gear ECG 28W T5
0.612 kg

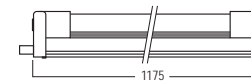

ILLUMINANT

C 685/LM.90

glass
for cleanroom built in light C 685
0.106 kg



FIXING SET

C 610/C.90

aluminium
with clamping screw M4 for fixing LED elements, clipping into ceiling extrusion C 608
0.004 kg

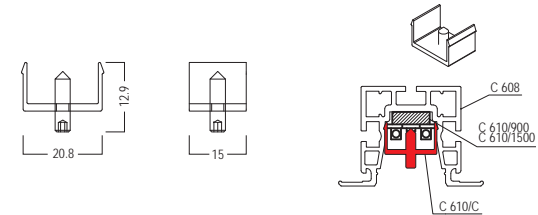

SPRINKLERSLEEVE

C 635.01

plastic
Sprinkler duct for installation on ceiling extrusions, for sprinkler pipes up to 1" or 25.4 mm, outside diameter 33.5 mm, Aluminum - pass-through sleeve with flange for flush mounting on ceiling extrusion
0.064 kg

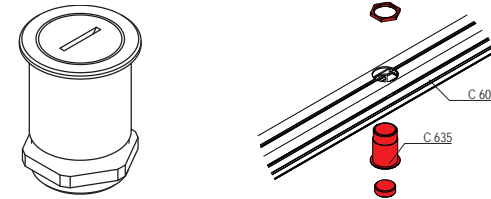

COVER EXTRUSION

2000 mm long

C 637/2000.50

Polycarbonat, satin finish
for internal LED-illumination of opencelling extrusion C 608
0.183 kg

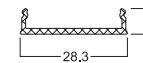

FIXING SET

C 650.37

zinc die cast/steel

consisting of Part A und B, for mounting to system groove
4,3 mm incl. 2 screws M 1557/20 and 2 set screws
M 1435/70, for suspension of cleanroom ceiling weith
thread rod M10 for loads up to 300 Kg
0,23 kg

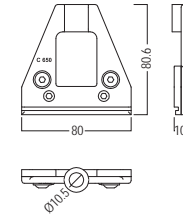

1 for loads up to 300 Kg

CLEANROOM SYSTEMS

DOOR SYSTEMS ELECTRONICS

TECHNICS 08/20

OCTANORM 

DOOR FRAME EXTRUSION

C 301.01

aluminium
for 40 mm door systems 6000 mm long
7.54 kg

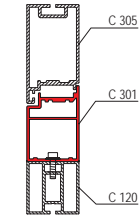
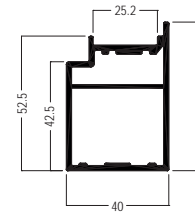

WINDOW PANEL EXTRUSION

C 305.01

aluminium
for 40 mm door systems 6000 mm long
8.62 kg

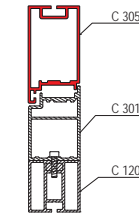
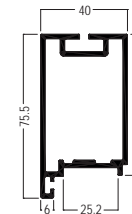

INTERNAL CORNER CONNECTOR for wing of a door

C 401.37

steel, zinc plated
incl. 4 countersunk head screws M6 for door frame
extrusion C 305
0.626 kg

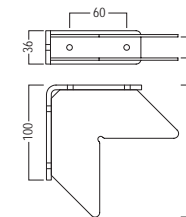

DOOR PANEL EXTRUSION

C 308.01

aluminium
for 40 mm door systems 5400 mm long
11.45 kg

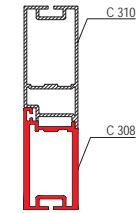
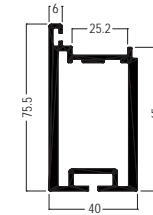

INTERNAL CORNER CONNECTOR

C 402.37

steel, zinc plated
incl. 4 countersunk screws M6 for door panel extrusion
C 308
0.591 kg

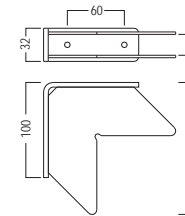

INTERNAL CORNER CONNECTOR for sliding door

C 407.37

steel
1.006 kg

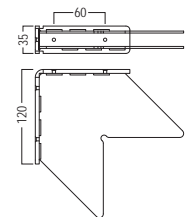

DOOR AND WINDOW EXTRUSIONS

Door Systems electronics

DOUBLE DOOR PANEL EXTRUSION

C 310.01

aluminium
for 40 mm door systems 6000 mm long
10.8 kg

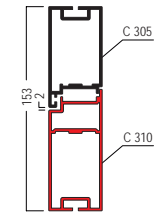
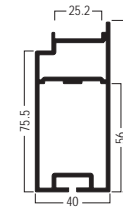

DOOR BEAM EXTRUSION

C 315.01

aluminium
for 40 mm door systems 6000 mm long
16.362 kg

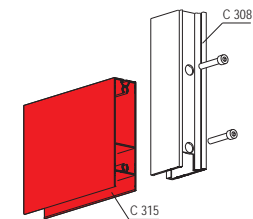
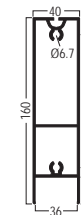

DOOR FRAME EXTRUSION

C 302.00.01

aluminium
for 60 mm door systems 6000 mm long
9.514 kg

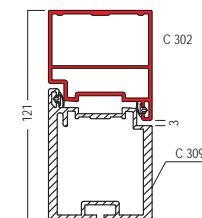
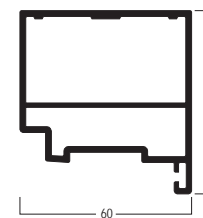

DOOR PANEL EXTRUSION

C 309.01

aluminium
for 60 mm door systems 5500 mm long
14.456 kg

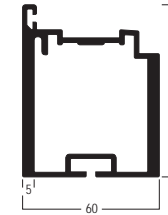

DOOR BEAM EXTRUSION

C 316.01

aluminium
for 60 mm door systems 6000 mm long
18.119 kg



INTERNAL CORNER CONNECTOR

for door
60 mm door

C 400.37

for door panel extrusion C 309
0.62 kg

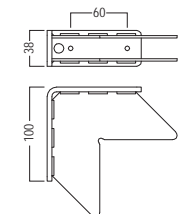

INTERNAL CORNER CONNECTOR

C 403.37

steel, zinc plated
for short door
0.516 kg

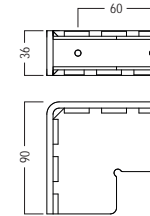

FRAME EXTRUSION

C 1210.01

aluminium
for 60 mm door systems for door glazing 6000 mm long
4.333 kg

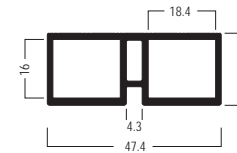

DOOR FRAME

right

C 350/R.01

aluminium
right, in combination with C 354-1NR or C 354-2NR for axis measurement 900 mm
6.528 kg

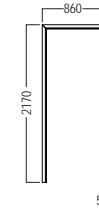

DOOR FRAME

left

C 350/L.01

aluminium
left, in combination with C 354-1NL or C 354-2NL for axis measurement 900 mm
6.528 kg

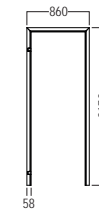

DOOR LEAF

right, single sided

C 354-1NR.01

aluminium
right, in combination with C 350/R, without panels for axis measurement 900 mm
16.598 kg

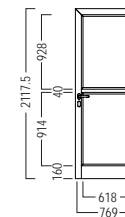

DOORS AND FRAMES

Door Systems electronics

DOOR LEAF
left, single sided

C 354-1NL.01

aluminium
left, in combination with C 350/L, without panels for axis measurement 900 mm
19.036 kg

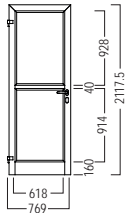

DOOR LEAF

C 354-2NR.01

aluminium
right, in combination with C 350/R, without panels for axis measurement 900 mm
16.801 kg

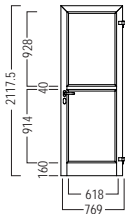

DOOR LEAF
left, double sided
40 mm

C 354-2NL.01

aluminium
in combination with C 350/L, without panels for axis measurement 900 mm
19.239 kg

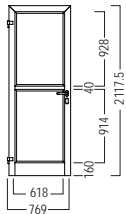

DOORS AND FRAMES

Door Systems electronics

DOOR FRAME right

C 351/R.01

aluminium
in combination with C 355-1NR or C 355-2NR for axis
measurement 1200 mm
7.128 kg

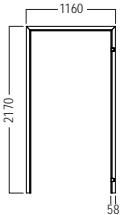

DOOR FRAME

C 351/L.01

aluminium
in combination with C 355-1NL or C 355-2NL for axis
measurement 1200 mm
7.128 kg

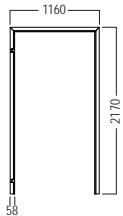

DOOR LEAF

C 355-1NR.01

in combination with C 351/R, without panels for axis
measurement 1200 mm
21.823 kg

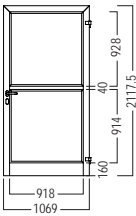

DOORS AND FRAMES

Door Systems electronics

DOOR LEAF

C 355-1NL.01

aluminium
in combination with C 351/L, without panels for axis
measurement 1200 mm
21.711 kg

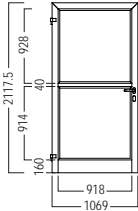

DOOR LEAF

C 355-2NR.01

aluminium
in combination with C 351/R, without panels for axis
measurement 1200 mm
22.11 kg

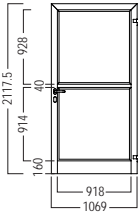

DOOR LEAF

C 355-2NL.01

aluminium
in combination with C 351/L, without panels for axis
measurement 1200 mm
21.998 kg

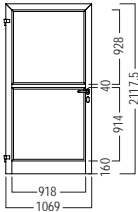

DOORS AND FRAMES

Door Systems electronics

DOOR FRAME

C 352/R.01

aluminium
 right, in combination with C 355-1NR and C 356-1NR or
 C 355-2NR and C 356-2NR for axis measurement 1800
 mm
 8.7 kg

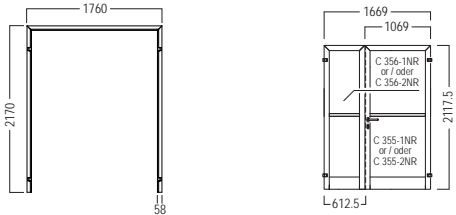

DOOR FRAME

C 352/L.01

aluminium
 left, in combination with C 355-1NL and C 356-1NL or
 C 355-2NL and C 356-2NL for axis measurement 1800
 mm
 8.7 kg

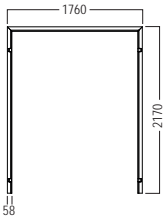

DOOR LEAF

C 356-1NR.01

aluminium
 DIN right, without panels in combination with C 352/R and
 C 355-1NR for axis measurement 1800 mm
 12.67 kg

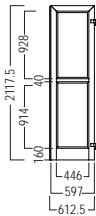

DOOR LEAF

C 356-1NL.01

aluminium

DIN left, without panels in combination with C 352/L and C 355-1NL for axis measurement 1800 mm
12.67 kg

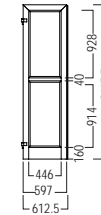

DOOR LEAF

C 356-2NR.01

aluminium

DIN right, double sided, without panels in combination with C 352/R and C 355-2NR for axis measurement 1800 mm
13.073 kg

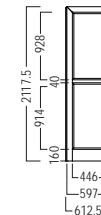

DOOR PANEL EXTRUSION

C 356-2NL.01

aluminium

DIN left, double sided, without panels in combination with C 352/L and C 355-2NL for axis measurement 1800 mm
13.073 kg

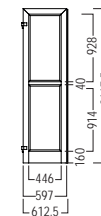

DOORS AND FRAMES

Door Systems electronics

DOOR FRAME

C 353/R.01

aluminium
 right, in combination with C 355-1NR and C 357-1NR or
 C 355-2NR und C 357-2NR for axis measurement 2400
 mm
 9.5 kg

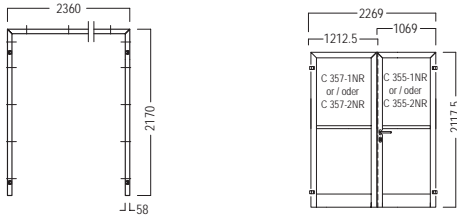

DOOR FRAME

C 353/L.01

aluminium
 left, in combination with C 355-1NL and C 357-1NL or
 C 355-2NL and C 357-2NL for axis measurement 2400
 mm
 9.645 kg

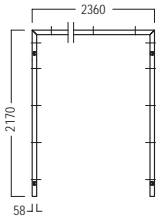

DOOR LEAF

C 357-1NR.01

aluminium
 DIN right, without panels in combination with C 353/R and
 C 355-1NR for axis measurement 2400 mm
 15.72 kg

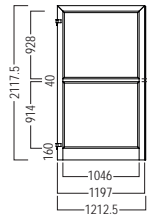

DOOR LEAF

C 357-1NL.01

aluminium

DIN left, without panels in combination with C 353/L and C 355-1NL for axis measurement 2400 mm
15.72 kg

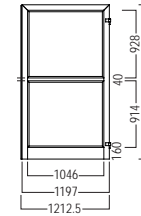

DOOR LEAF

C 357-2NR.01

aluminium

DIN right, without panels in combination with C 353/R and C 355-2NR for axis measurement 2400 mm
16.07 kg

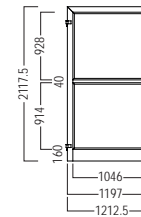

DOOR LEAF

C 357-2NL.01

aluminium

DIN left, without panels in combination with C 353/L and C 355-2NL for axis measurement 2400 mm
16.07 kg

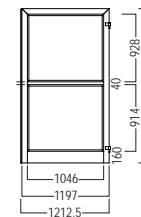

DOOR FRAME

C 350/R PRO.01

aluminium

single door: in combination with C 354/R PRO double door:
in combination with C 354/R PRO and C 354/L PRO

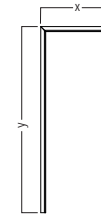

DOOR FRAME

C 350/L PRO.01

aluminium

single door: in combination with C 354/L PRO double door:
in combination with C 354/L PRO and C 354/R PRO

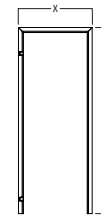

DOOR FRAME

C 354/L PRO.01.80

aluminium

in combination with C 350/L PRO, without panels

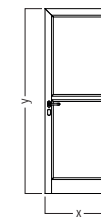

DOOR FRAME

C 356/R PRO.01

aluminium
in combination with C 350/R PRO and C 354/R PRO,
without panels

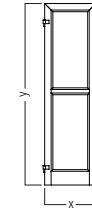

DOOR LEAF

Fixed leaf, left

C 356/L PRO.01

aluminium
in combination with C 350/L PRO and C 354/ L PRO,
without panels

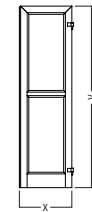

DOOR ACCESSORIES

Door Systems electronics

CONTROLLER

C 572.90

plastic
consisting of 1 x controller for 2 doors 4 x lights red/green
with emergency power-off switch 2 x wire for door opener
2.613 kg

CONTROLLER

C 574.90

plastic
consisting of 1 x controller for 3-4 doors 8 x lights red/green
with emergency power-off switch 4 x wire for door opener
4.281 kg

END CAP

for hole diameter 15 mm for door frame

C 421.31

plastic

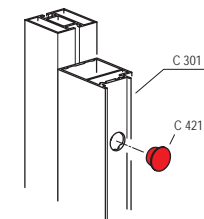

DOOR ACCESSORIES

Door Systems electronics

END CAP

for hole diameter 14 mm for door leaf

C 422.30

plastic

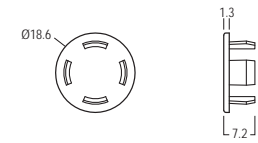

MORTISE LOCK

C 501.90

steel
for profile cylinder lock
0.655 kg

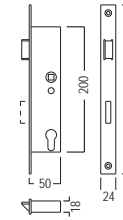

MORTISE LOCK

C 501 CH.90

steel
for KABA cylinder lock
0.655 kg

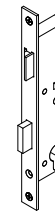
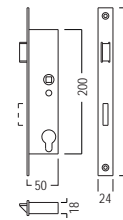

DOOR ACCESSORIES

Door Systems electronics

MORTISE LOCK with panic function

C 502.90

steel
available in the following finishes: C 502 B-L C 502 C-L
C 502 D-L C 502 B-R C 502 C-R C 502 D-R C 502 E
0.651 kg

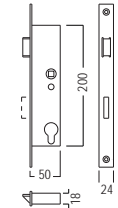

MORTISE LOCK with panic function

C 502 CH.90

steel
for KABA cylinder lock available in the following finishes:
C 502 CH B-L C 502 CH B-R C 502 CH E
0.651 kg

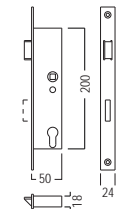

LOCK CYLINDER

C 503.38

steel
for C 501
0.222 kg

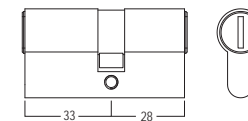

DOOR ACCESSORIES

Door Systems electronics

LOCK FACE PLATE



C 505.90

aluminium
für C 501 1 pair
0.031 kg

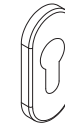

LOCK FACE PLATE



C 505 CH.90

aluminium
for C 501 CH 1 pair
0.031 kg

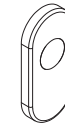

LOCK FACE PLATE



C 506.90

aluminium
1 pair
0.032 kg

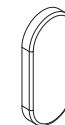

DOOR ACCESSORIES

Door Systems electronics

DOOR HANDLE SET

C 510.90

aluminium
consisting of: 2 x handle 1 x bar steel 2 x blind face plate
C 506
0.754 kg

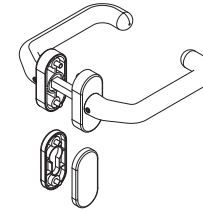

DOOR HANDLE

C 536.90

aluminium
For 8 mm square bar steel door knob
0.241 kg

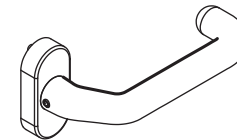

DOOR KNOB

C 537.90

aluminium
0.311 kg

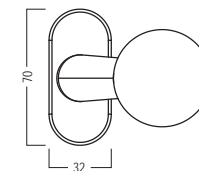

DOOR ACCESSORIES

Door Systems electronics

SQUARE BAR STEEL

C 538.90

steel

9 mm on one side reduced to 8 mm for combination with door handle and door knob
0.032 kg

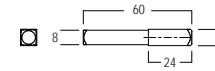

SQUARE BAR STEEL

9 x 95 mm

C 510/1.90

steel

0.059 kg

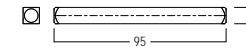

DOOR HINGE



C 515.90

aluminium

incl. mounting accessory
0.392 kg

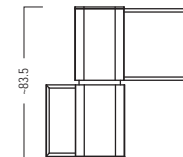

DOOR ACCESSORIES

Door Systems electronics

STRIKER PLATE

basic 270 x 24 mm



C 520.90

steel
0.116 kg

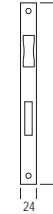

ELECTRIC DOOR OPENER

for all-glass doors



C 539.90

mounting horizontal and vertical possible can be mounted door left and right by rotating 180°
adjustable door thickness from 9-12 and 13-15 mm
0.345 kg

CABINET LOCK



C 585.90

plastic
black optional fitting sideways or from above to lock doors or drawer locking by key switch or code or cardreader system
0.131 kg

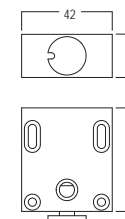

DOOR ACCESSORIES

Door Systems electronics

TRANSFORMER for pass through box



C 587.90

plastic
24 V DC 25 W max.
0.102 kg

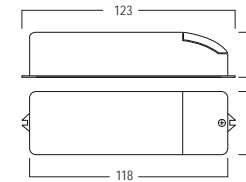

REED SWITCH



C 591.90

plastic
for monitoring of windows and doors if they are open
0.06 kg

FLOOR BUSH

C 532.37

brass
0.089 kg

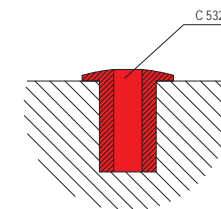
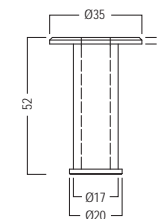

DOOR ACCESSORIES

Door Systems electronics

DOOR BUMPER



C 533.01

aluminium
0.08 kg

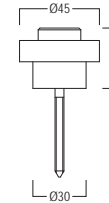

GASKET for C 354

C 540.90

plastic
Rubber/aluminium for single sided door, axis measurement
900 mm 741 mm long
0.46 kg

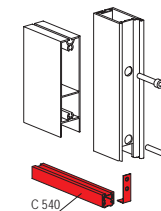
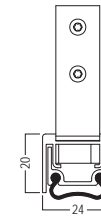

GASKET for C 355

C 541.90

plastic
Rubber/aluminium for single sided door, axis measurement
1200 mm for double sided door, axis measurement
1800/2400 mm 1041 mm long
0.644 kg

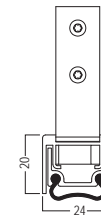

DOOR ACCESSORIES

Door Systems electronics

GASKET for C 356

C 542.90

plastic

Rubber/aluminium for stationary leaf C 356 or double sided door, axis measurement 1800 mm 590 mm long
0.39 kg

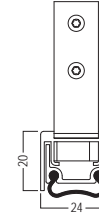

GASKET for C 537

C 543.90

plastic

Rubber/aluminium for stationary leaf C 537 or 2 sided door, axis measurement 2400 mm 1190 mm long
0.744 kg

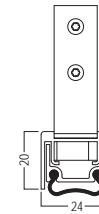

DOOR CLOSER automatic

C 545.90

steel

3.205 kg

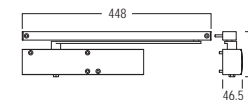

GLASS DOORS

Door Systems electronics

DOOR
Glass door
left

C 330/L.90

glass
aluminium / tempered safety glass 8 mm, "clear"
39.653 kg

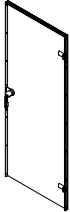

DOOR
Glass door
right

C 330/R.90

glass
aluminium / tempered safety glass 8 mm, "clear"
39.653 kg

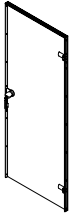

DOOR FRAME EXTRUSION
5000 mm long

W 490.01

aluminium
with insert groove for door seal W 492
9.08 kg

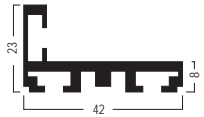

GASKET

W 492.36

plastic
PVC soft for door frame extrusion W 490 roll of 20 m
1.38 kg

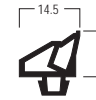

DOOR CYLINDER mounted into door



W 514.38

steel

1 × dead lock cylinder, for mounting into door W 415, incl.
3 × keys W 415/S
0.222 kg

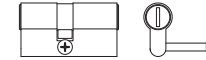

KEY



W 514/S.38

nickel-plated

for dead lock cylinder W 514
0.011 kg

GASKET

C 321.33

plastic

rubber 10 m
0.26 kg



SELF TAPPING SCREW

C 390.37

steel, zinc plated
for door frame connection
0.003 kg

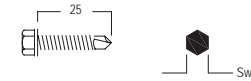

SELF TAPPING SCREW

C 693-4819.37

steel, zinc plated
self drilling screw with truss head ZEBRA Pias
0.002 kg



DOOR HINGE with indexed position

C 410.33

plastic
black with lock-in position 150°
0.062 kg

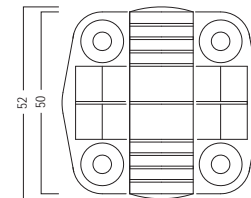

ACCESSORIES GLASS DOORS

Door Systems electronics

DOOR HINGE

without indexed position



C 411.33

plastic
black without lock-in position
0.058 kg

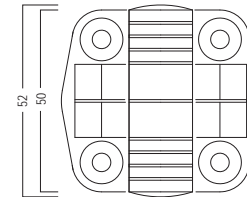

DOOR HINGE



C 335.01

aluminium
Meroni - GLISS
0.102 kg

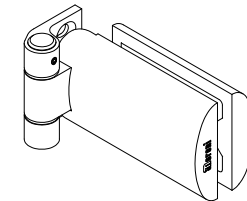

DOOR HANDLE



C 337.01

aluminium
Meroni - COMBINA
0.075 kg

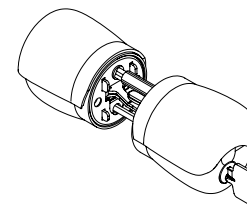

CONTENT

WALL SYSTEMS PHARMACEUTICS	103
CEILING SYSTEMS PHARMACEUTICS	112
DOOR SYSTEMS PHARMACEUTICS	114

CLEANROOM SYSTEMS

WALL SYSTEMS PHARMACEUTICS

TECHNICS 08/20

OCTANORM 

EXTRUSIONS

Wall Systems Pharmaceuticals

UPRIGHT EXTRUSION

T-connection
100 x 140 mm, P98

C 1030.00

aluminium
2-parts, connected with 1 extrusion connectors E 450 6000
mm long
30.402 kg

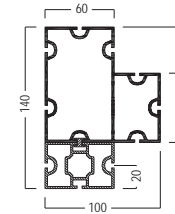

UPRIGHT EXTRUSION

C 1040.00

aluminium
3-parts, connected with 2 extrusion connectors E 450 6000
mm long
41.411 kg

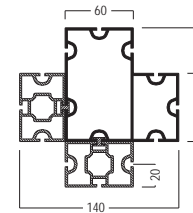

U-CHANNEL EXTRUSION
for floor and ceiling

C 1005.00

aluminium
6000 mm long
8.472 kg

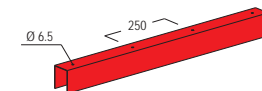
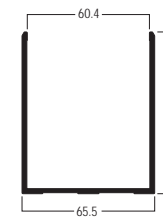

COMPONENTS

Wall Systems Pharmaceuticals

INTERNAL CORNER CONNECTOR for frame extrusion C 1105

C 1111.90

aluminium
for frame extrusion C 1105 will be glued on installation
6000 mm long
17.22 kg

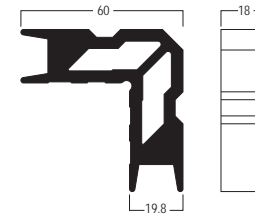

INTERNAL CORNER CONNECTOR for frame extrusion C 1220

C 1295.00

aluminium
for frame extrusion C 1220 will be glued on installation
6000 mm long

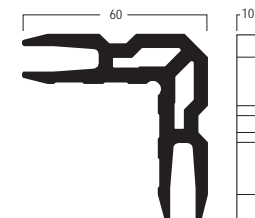

FIXING SET

C 472.37

steel/plastic
for fixing the wall, ceiling panels and glass elements to
system groove of subconstruction
0.006 kg

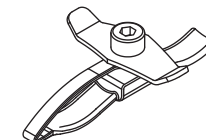
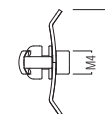

COMPONENTS

Wall Systems Pharmaceuticals

CHANNELING EXTRUSION

C 1301.01

aluminium
6000 mm long
2.624 kg

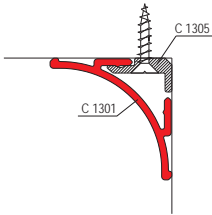
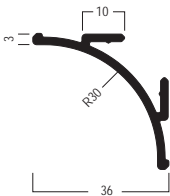

ADAPTOR EXTRUSION

5000 mm long

C 1305.35

plastic
to fix extrusions C 1301
0.395 kg

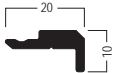

ADAPTOR for channeling extrusion 200 mm long

C 1311.35

plastic
to fix extrusions C 1301
0.016 kg

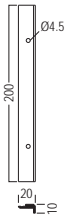

COMPONENTS

Wall Systems Pharmaceuticals

INTERNAL CONNECTOR

C 1330.30

plastic
for connection of 2 extrusions C 1301
0.105 kg

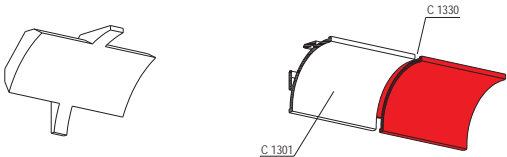

KNUCKLE

C 1332.30

plastic
for connection of 2 extrusions C 1301
0.014 kg

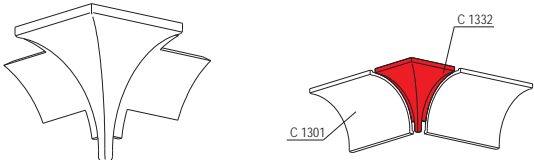

KNUCKLE

C 1333.30

plastic
for connection of 3 extrusions C 1301
0.021 kg

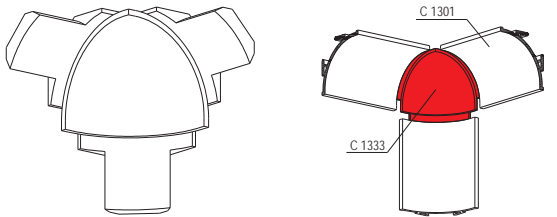

COMPONENTS

Wall Systems Pharmaceuticals

GASKET

C 1340.30

plastic
25 m long
1.362 kg



GASKET

10.000 mm long

C 1345.30

plastic
for internal corner
0.736 kg



CAVITY WALL BOX

installation depth 35 mm



C 480.90

plastic
68 mm dia.
0.019 kg

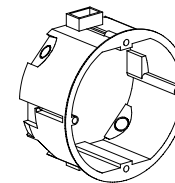

COMPONENTS

Wall Systems Pharmaceuticals

CAVITY WALL BOX

installation depth 45 mm

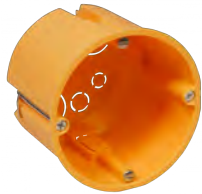

C 481.90

plastic
dia. 68 mm
0.021 kg

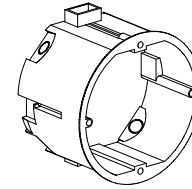

FASCIA

C 1250.80

sheet metal

Steel sheet, powdercoated, 1mm installation depth 19 mm, edges closed overleaf, for quick and wall fastening combined with mounting parts C 472 to be used in combination with end uprights C 1050 and steel panels (vertical fitting position) special length

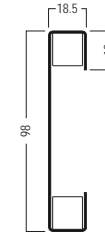

FASCIA

C 1270/R.80

sheet metal

1 mm, powdercoated, installation depth 19 mm, edges closed overleaf, with raster holes 5 x 60 mm / division 70 mm for quick wall fastening combined with mounting parts C 472 to be used in combination with door elements (vertical fitting position) special length

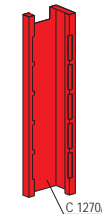
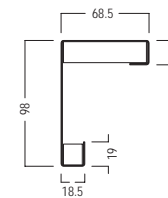

C 1270/R

FASCIA

C 1270/L.80

sheet metal

1 mm, powdercoated, installation depth 19 mm, edges closed overleaf, with raster holes 5 x 60 mm / division 70 mm for quick wall fastening combined with mounting parts C 472 to be used in combination with doors (vertical fitting position) special length

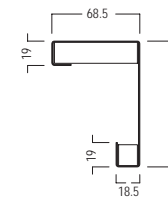

C 1270/L

FLAT EXTRUSION

3000 mm long

C 1120.90

plastic

plastic for fixing glass elements C 1850 und C 1855
0.75 kg

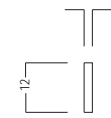

FLAT EXTRUSION

400 mm long

C 1122.90

plastic

plastic for fixing glass elements C 1850 and C 1855
0.01 kg

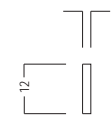

CONTENT

CEILING SYSTEMS PHARMACEUTICS

CEILING SYSTEMS PHARMACEUTICS

113

TECHNICAL INFORMATION

CEILING SYSTEMS PHARMACEUTICS

Ceiling Systems Pharmaceutics

SQUARE EXTRUSION
with 4 system grooves
5000 mm long

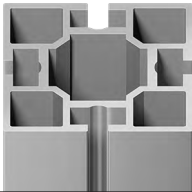

M 1000.01

aluminium
for connection on 4 sides, tension lock Z 961/8 can be mounted in 2 positions, 5000 mm long
5.782 kg

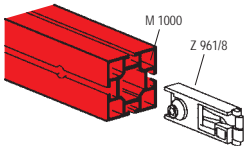
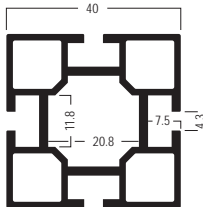

FIXING SET

C 472.37

steel/plastic
for fixing the wall, ceiling panels and glass elements to system groove of subconstruction
0.006 kg

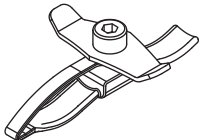
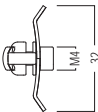

THREAD ROD
M8
1000 mm



C 661.37

steel, zinc plated
1000 mm long
0.279 kg

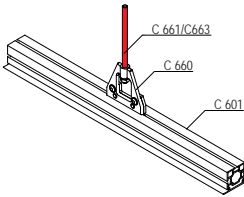
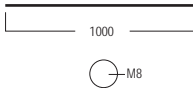

CONTENT

DOOR SYSTEMS PHARMACEUTICS

DOOR SYSTEMS PHARMACEUTICS

115

TECHNICAL INFORMATION

DOOR
for axis measurement
1200 mm

C 1218.80

aluminium
aluminium left, include door frame, without panels, for axis measurement 1200 mm - 40mm

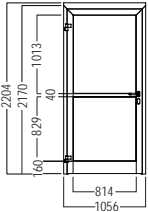

DOOR
for axis measurement
1800 mm

C 1238.80

aluminium
aluminium left, include door frame, without panels, for axis measurement 1800 mm

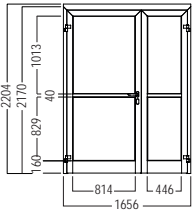

DOOR
for axis measurement
2400 mm

C 1248.80

aluminium
aluminium left, include door frame, without panels, for axis measurement 2400 mm

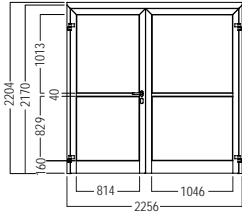

DOOR
for axis measurement
1200 mm

C 1214.80

aluminium
aluminium right, include door frame, without panels, for
axis measurement 1200 mm - 40mm
16 kg

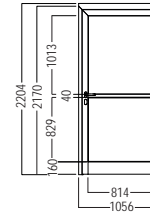

DOOR
for axis measurement
1800 mm

C 1234.80

aluminium
aluminium right, include door frame, without panels, for
axis measurement 1800 mm

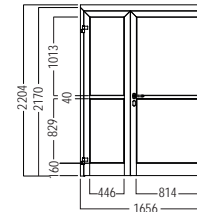

DOOR
for axis measurement
2400 mm

C 1244.80

aluminium
aluminium right, include door frame, without panels, for
axis measurement 2400 mm

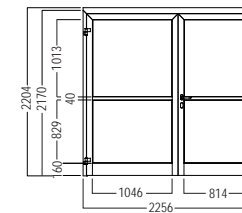

FRAME EXTRUSION for 40 mm pharma glazing

C 1220.00.01

aluminium
for 40 mm door systems for door glass elements 6000 mm long
3.424 kg

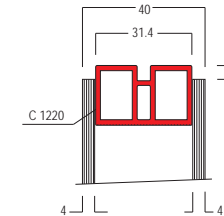
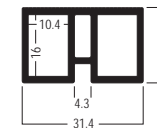

FIXING ANGLE for pharma door panel (40 mm and 60 mm)

C 1236.37

steel
to be riveted into door panel C 1282, C 1284, C 1289, C 1290
0.007 kg

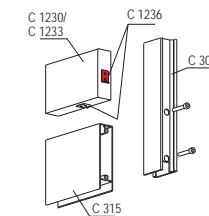
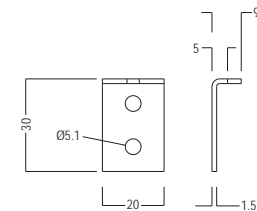

LOCK PLATE for floor beam Pharma door 40 mm

C 1240.37

steel, zinc plated
incl. 2 fixing screws M8 for doors C 1201.....C 1215
0.133 kg

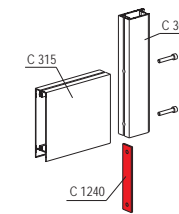
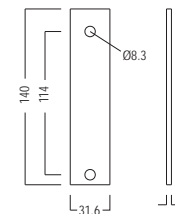

DOOR GLAZING

for 40 mm
Pharma-fixed leave C 1234/C 1238

C 1222.90

Glass/aluminium

glass/aluminium tempered glass 2 x 4 mm, installation depth 40 mm edges closed all round for mounting to doors C 1234, C 1238
10.681 kg

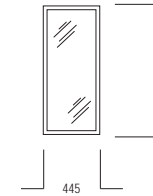

DOOR GLAZING

for 40 mm
Pharma-active leaf C 1214/C 1218

C 1224.90

Glass/aluminium

tempered glass 2 x 4 mm, installation depth 40 mm edges closed all round for mounting to doors C 1214, C 1218, C 1234, C 1238, C 1244, C 1248
18.6 kg

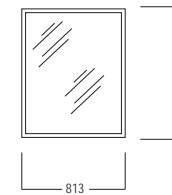

DOOR GLAZING

for 40 mm doors

C 1229.90

Glass/aluminium

tempered glass 2 x 4 mm, installation depth 40 mm edges closed all round for mounting to special size doors

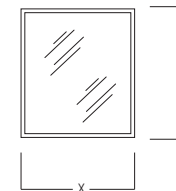

DOOR GLAZING
for 40 mm
Pharma-fixed leaf C 1244/C 1248

C 1230.90

Glass/aluminium
tempered glass 2 x 4 mm, installation depth 40 mm edges closed all round for mounting to doors C 1244, C 1248
23.8 kg

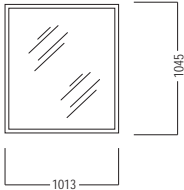

DOOR PANEL
for 40 mm pharma door

C 1282.80

sheet metal
1 mm, powdercoated, installation depth 40 mm, edges closed all round, for mounting to doors C 1234 and C 1238

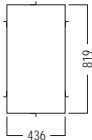

DOOR PANEL
for 40 mm pharma door

C 1284.80.85

sheet metal
1 mm, powdercoated, installation depth 40 mm, edges closed all round, for mounting to doors C 1214, C 1218, C 1234, C 1238, C 1244, C 1248

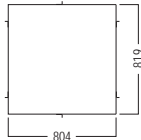

DOOR PANEL for 40 mm pharma door

C 1289.80

sheet metal

Steel sheet 1 mm, powdercoated, installation depth 40 mm, edges closed all round, for mounting to special size doors

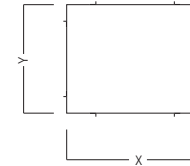

FLOOR EXTRUSION Part 2 for SM60 wall

C 1405.00.80

aluminium

aluminium for installation of wall elements system "Dagard"
6000 mm long
10.81 kg

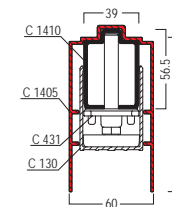
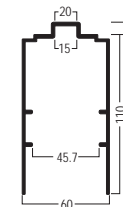

DOOR PANEL for 40 mm pharma door

C 1290.80

sheet metal

1 mm, powdercoated, installation depth 40 mm, edges closed all round, for mounting to doors C 1244 and C 1248

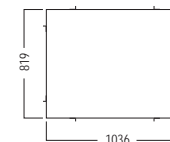

FLOOR EXTRUSION

Part 1
for SM60 wall

C 1410.00

aluminium
with 11 drillings 10.5 mm dia. for adjustment of adjustable
foot C 431 6000 mm long
6.43 kg

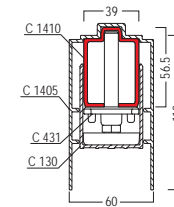
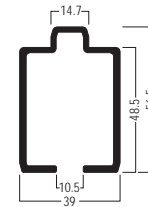

CONTENT

EXTRUSIONS IN GENERAL

60 X 60 MM	123
80 X 80 MM	124
160 X 80 MM	128
80 MM	129
120 X 120 MM	130
40 X 28 MM	133
60 X 40 MM	134
80 X 40 MM	135
120 X 80 MM	137
200 X 40 MM	138
80 MM	139
100 X 32 MM	140
32 X 32 MM	141
32 X 16 MM	148
37 X 16 MM	149
40 X 16 MM	150
40 X 32 MM	151
50 X 16 MM	152
70 X 16 MM	153

ADJUSTABLE FOOT for square extrusions 60 mm M10



M 1067.37

steel
thread M10, incl. 2 set screws M 1075/20 (M4)
0.236 kg

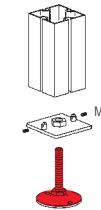
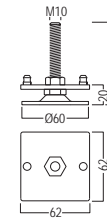

80 X 80 MM

Extrusions in general

SQUARE EXTRUSION

80 mm
5000 mm long



M 1020.01

aluminium
adaptors with tension lock M 1101, M 1103, adaptors with safety tension lock M 1114, M 1116 and adaptor for hinged end plates M 1281 can be mounted, 5000 mm long
11.514 kg

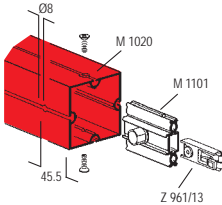
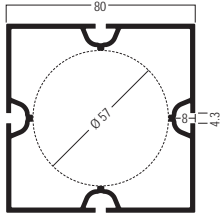

SQUARE EXTRUSION

80 mm
6000 mm long



M 1021.01

aluminium
adaptors with tension lock M 1101, M 1103, adaptors with safety tension lock M 1114, M 1116 and adaptor for hinged end plates M 1281 can be mounted, 6000 mm long
12.886 kg

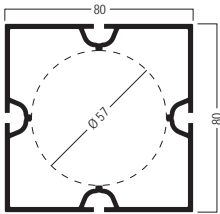

ADAPTOR

with tension lock Z 961/13
80 mm



M 1101.00

aluminium
incl. 1 tension lock Z 961/13, 1 collar guide M 1102/2 and 2 countersunk screws M 1100/20 (M5), for all square and round extrusions 80 mm
0.144 kg

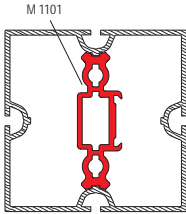
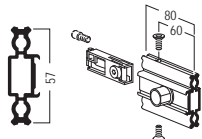

80 X 80 MM

Extrusions in general

BASE PLATE
300 x 300 mm



M 1406.21

steel
incl. adaptor M 1406/2, 2 countersunk screws M 1406/20 (M8) and 4 countersunk screws M 1611/20 (M5) for all square and round extrusions 80 mm
4.602 kg

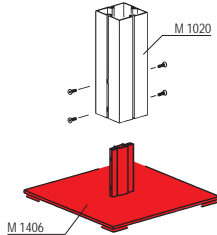
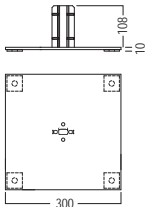

SQUARE EXTRUSION
80 mm
5000 mm long

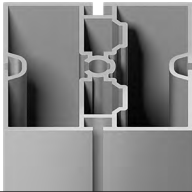

M 1018.01

aluminium
tension lock Z 961/8 can be mounted
14.91 kg

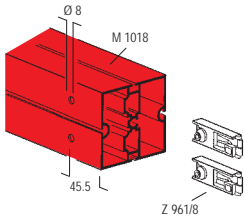
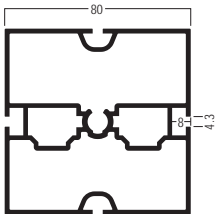

SQUARE EXTRUSION
80 mm
6000 mm long

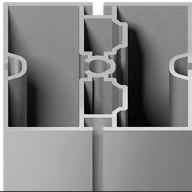

M 1019.01

aluminium
tension lock Z 961/8 can be mounted, 6000 mm long
17.8 kg

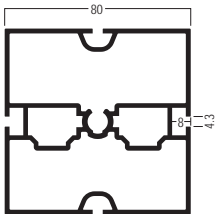

80 X 80 MM

Extrusions in general

END CAP



M 1034.35

plastic
for square extrusions M 1018, M 1020 and lightrack mounting extrusion M 1059
0.021 kg

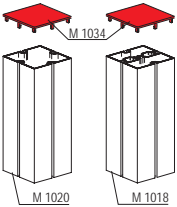
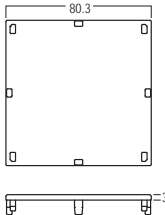

END PLATE



M 1035.21

steel
incl. 2 set screws M 1075/20 (M4), for square extrusions M 1018, M 1020 and lightrack mounting extrusion M 1059
0.159 kg

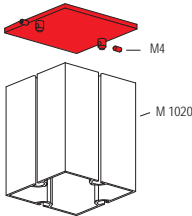
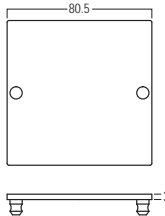

COVER EXTRUSION for extrusions 80 mm 5000 mm long



M 1367.00

aluminium
can be powder-coated or film laminated, with slide-on technique for all extrusions 80 mm
2.12 kg

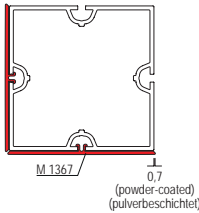
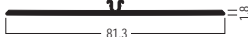

SPIGOT TUBE

for M 1020 / M1021 / M 1017



M 1424.00

aluminium
for extension of upright extrusions
0,891 kg

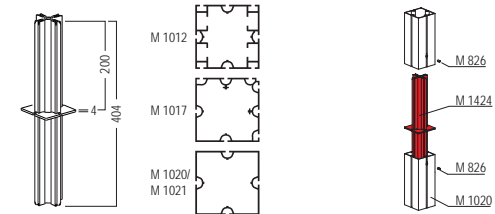

160 X 80 MM

Extrusions in general

RECTANGULAR EXTRUSION

160 x 80 mm
6930 mm long



M 1052.01

aluminium
adaptor with tension lock M 1103 can be mounted, 6930 mm long
28.346 kg

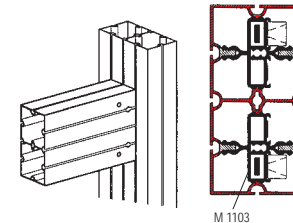
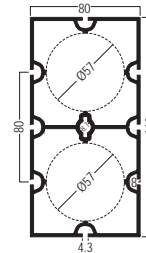

END PLATE



M 1097.21

steel
incl. 2 set screws M 1075/20 (M4), for rectangular extrusion M 1052
0.313 kg

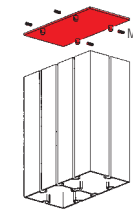
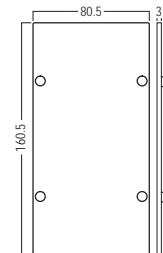

ADJUSTABLE FOOT



M 1098.37

steel
thread M10, incl. 2 set screws M 1075/20 (M4), for rectangular extrusion M 1052
0.532 kg

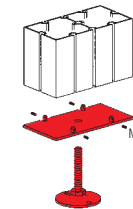
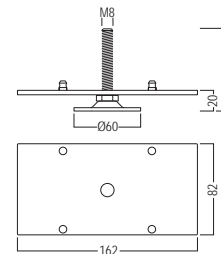

ANGLE EXTRUSION

135°
5000 mm long

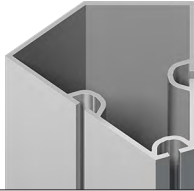

M 1070.01

aluminium
5000 mm long
8.375 kg

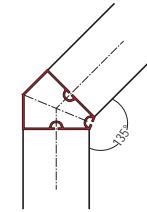
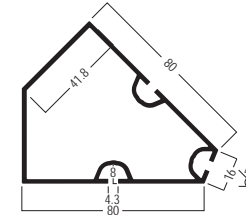

END PLATE

for M 1070
135°



M 1095.21

steel
incl. 2 set screws M 1075/20 (M4), for exterior corner
extrusion M 1070
0.101 kg

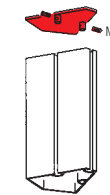
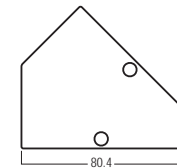

ADJUSTABLE FOOT

M10 / 135°



M 1096.37

steel
thread M10, incl. 1 set screw M 1075/20 (M4), for exterior
corner extrusion M 1070
0.263 kg

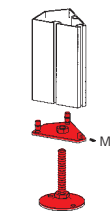
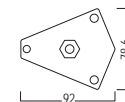
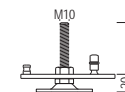

120 X 120 MM

Extrusions in general

SQUARE EXTRUSION

120 mm
5000 mm long



M 225.01

aluminium
adaptors with tension lock M 1102, M 1122, adaptors with safety tension lock M 1124, M 1126 and adaptor for hinged end plates M 1282 can be mounted, 5000 mm long 19.806 kg

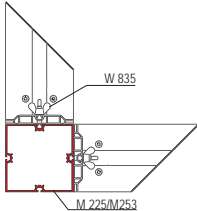
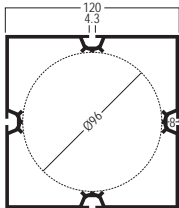

SQUARE EXTRUSION

120 mm
6000 mm long



M 226.01

aluminium
adaptors with tension lock M 1102, M 1122, adaptors with safety tension lock M 1124, M 1126 and adaptor for hinged end plates M 1282 can be mounted, 6000 mm long 22.708 kg

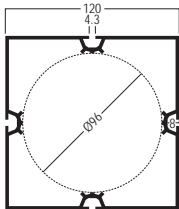

ADAPTOR

with 2 tension locks Z 961/13
120 mm



M 1102.00

aluminium
incl. 2 tension locks Z 961/13, 1 knurled-head screw M 1102/21 (M4) for beam retainer M 1106, 2 collar guides M 1102/2 and 4 countersunk screws M 1102/20 (M6), for all closed square and round extrusions 120 mm 0.339 kg

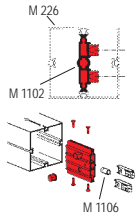
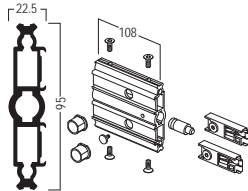

120 X 120 MM

Extrusions in general

BASE PLATE 450 x 450 mm

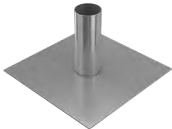

M 1426.21

steel
incl. adaptor M 825/A and 4 countersunk screws eZ5030/20 (M10) for all square extrusions 120 mm and all closed round extrusions 120 mm dia
11.44 kg

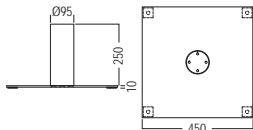

REINFORCING PLATE



M 826.00

aluminium
incl. 1 set screw M 826/S (M6)
0.005 kg

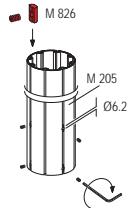

END PLATE for square extrusions 120 mm

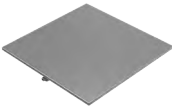

M 274.21

steel
incl. 2 set screws M 1075/20 (M4), for all square extrusions 120 mm
0.36 kg

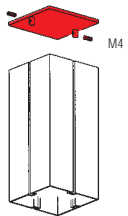
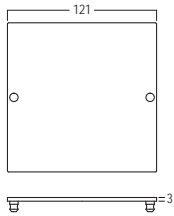

120 X 120 MM

Extrusions in general

ADJUSTABLE FOOT

120 mm



M 285.37

steel
thread M16, incl. 2 set screws M 1075/20 (M4), for all square extrusions 120 mm
0.79 kg

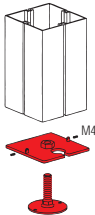
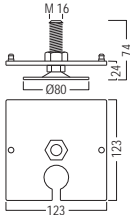

SPIGOT TUBE

for extrusions 120 mm



M 1419.00

aluminium
for extension of upright extrusions, for all square extrusions 120 mm
1.842 kg

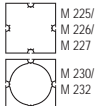
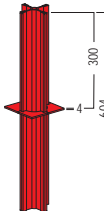
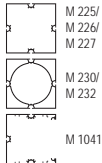
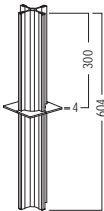

40 X 28 MM

Extrusions in general

RECTANGULAR EXTRUSION

40 x 28 mm
5000 mm long

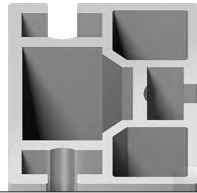

M 1068.01

aluminium
tension lock Z 961/8 can be mounted, 5000 mm long
4.756 kg

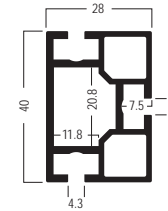

60 X 40 MM

Extrusions in general

RECTANGULAR EXTRUSION

60 x 40 mm

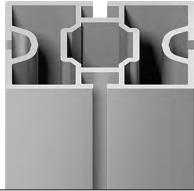

M 1082.01

aluminium

tension lock Z 961/8 can be mounted in 2 positions 6000 mm long
mm long
10.732 kg

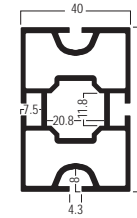

80 X 40 MM

Extrusions in general

RECTANGULAR EXTRUSION

80 x 40 mm
5000 mm long



M 1025.01

aluminium
tension lock Z 961/8 can be mounted in 2 positions, 5000 mm long
10.218 kg

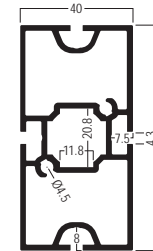

RECTANGULAR EXTRUSION

80 x 40 mm
6000 mm long



M 1026.01

aluminium
tension lock Z 961/8 can be mounted in 2 positions, 6000 mm long
12.7 kg

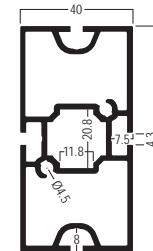

END PLATE

for rectangular extrusions
80 x 40 mm



M 1085.21

steel
incl. 2 set screws M 1075/20 (M4), for rectangular extrusions 80 x 40 mm
0.08 kg

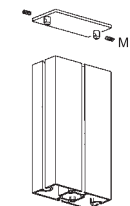
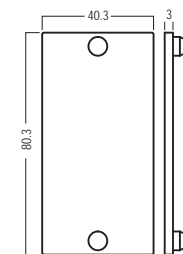

80 X 40 MM

Extrusions in general

ADJUSTABLE FOOT
for rectangular extrusion
80 x 40 mm



M 1086.37

steel
thread M8 incl. 2 set screws M 1075/20 (M4), for
rectangular extrusions 80 x 40 mm
0.181 kg

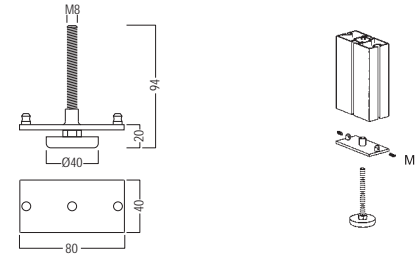

120 X 80 MM

Extrusions in general

END PLATE



M 1087.21

steel
incl. 2 set screws M 1075/20 (M4), for rectangular extrusion M 1030
0.12 kg

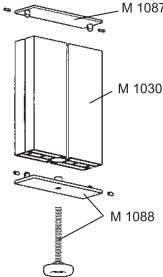
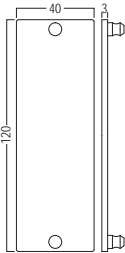

ADJUSTABLE FOOT



M 1088.37

steel
thread M8, incl. 2 set screws M 1075/20 (M4), for rectangular extrusion M 1030
0.237 kg

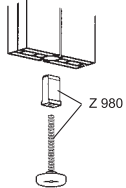
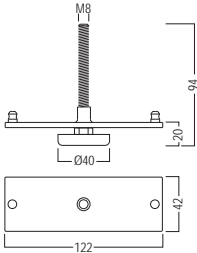

200 X 40 MM

Extrusions in general

SUPPORTING BEAM

200 × 40 mm
7000 mm long



M 770.01

aluminium

2 × tension lock Z 961/8 can be mounted in 2 positions or
3 × tension lock Z 961/13 with Z 161/A, 7000 mm long
35.533 kg

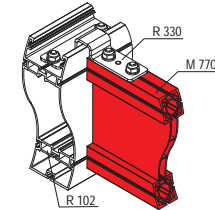
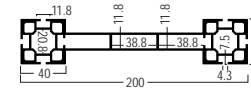

REINFORCEMENT

for system groove



M 1129.37

steel

incl. 3 set screws M 1435/70 (M8) and 2 round head
screws with flange M 1557/20 (M6)
0.376 kg

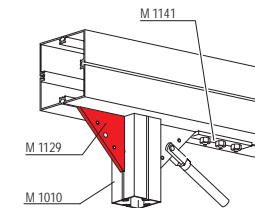
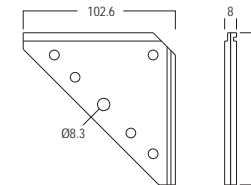

REINFORCING PLATE

for square extrusions 80 mm

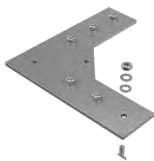

M 1164.21

steel

incl. 6 hammerhead screws M 1473 (M8)
1.535 kg

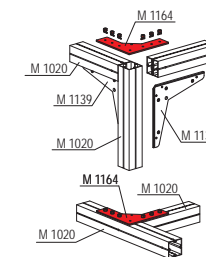
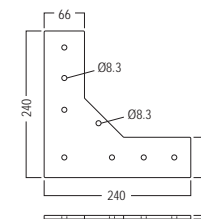

Attention: item has to be used for safety reasons as "beam retainer"

END PLATE
for round extrusions
80 mm



M 1235.21

steel
incl. 2 set screws M 1075/20 (M4), for all round extrusions
80 mm dia.
0.129 kg

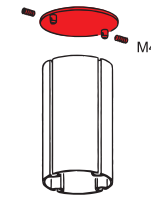
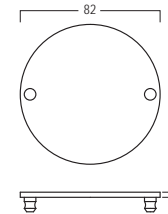

ADJUSTABLE FOOT
for round extrusions 80 mm
M10



M 1234.37

steel
thread M10, incl. 2 set screws M 1075/20 (M4), for all
round extrusions 80 mm dia.
0.269 kg

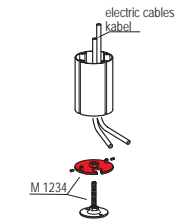
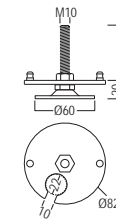

100 X 32 MM

Extrusions in general

DOUBLE TRIANGULAR
5000 mm long

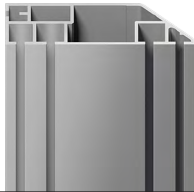

S 1310.01

aluminium
9,28 kg

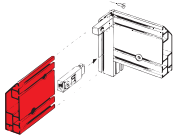
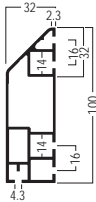

drilling jig BS 6
with distance block ZBS 140
Bohrschablone BS 6
mit Distanzblock ZBS 140

32 X 32 MM

Extrusions in general

DOUBLE TRIANGULAR

5000 mm long



S 1303.01

aluminium
3.196 kg

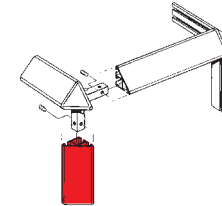
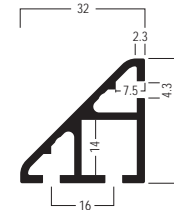

QUARTER-ROUND EXTRUSION

5000 mm long

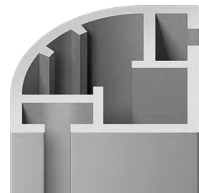

S 1100.01

aluminium
4.06 kg

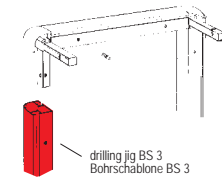
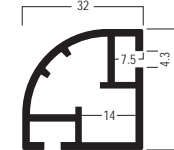

QUARTER-ROUND EXTRUSION

5000 mm long



S 1105.01

aluminium
4.02 kg

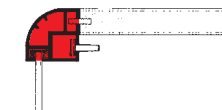
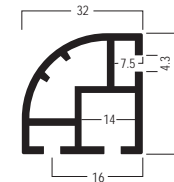

32 X 32 MM

Extrusions in general

END CAP



S 1130.35

plastic
0.004 kg

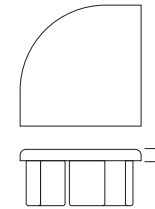

END PLATE



S 1131.39

zinc die cast
0.036 kg

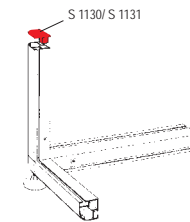
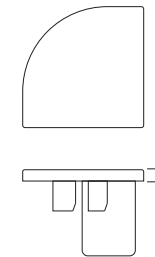

THREADED PLUG



S 1132.00

zinc die cast
thread M10 for quarter-round extrusions S 1100, S 1105
0.035 kg

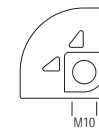
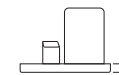

32 X 32 MM

Extrusions in general

END PLATE



S 1334.39.41

zinc die cast
0.03 kg

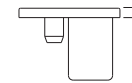
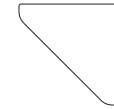

THREADED PLUG



S 1336.00

zinc die cast
with female thread M10 for triangular extrusion S 1303
0.03 kg

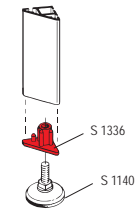
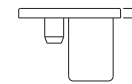

SQUARE EXTRUSION

32 mm
5000 mm long



S 1125.01

aluminium
4.032 kg

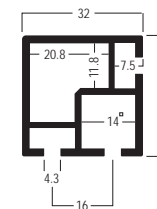

32 X 32 MM

Extrusions in general

END PLATE

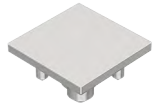

S 1142.39

zinc die cast
0.032 kg

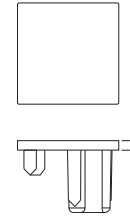

KNUCKLE



S 1173.39

zinc die cast
0.209 kg

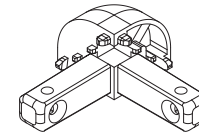

KNUCKLE



S 1170.39

zinc die cast
0.256 kg

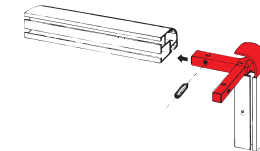
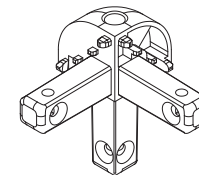

32 X 32 MM

Extrusions in general

KNUCKLE



S 1175.39

zinc die cast
0.262 kg

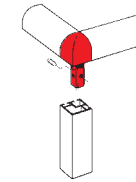
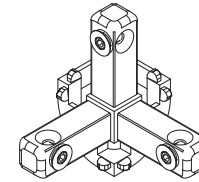

KNUCKLE



S 1180.39

zinc die cast
0.261 kg

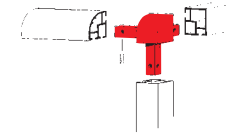
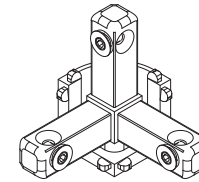

KNUCKLE



S 1333.39.41

zinc die cast
0.196 kg

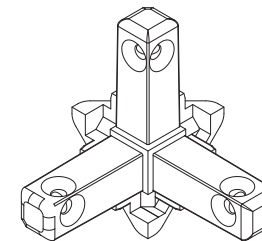

KNUCKLE



S 1340.39.41

zinc die cast
0.229 kg

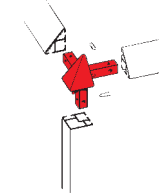
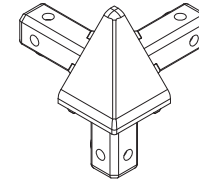

KNUCKLE joint



S 1341.39

zinc die cast
incl. 3 countersunk screws E 111/m (M6) and 3 set screws E 111/g (M6) for mounting 1 triangular extrusion S1303 and 2 square extrusions S 1125

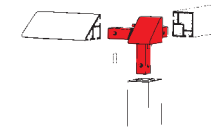
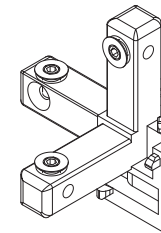

KNUCKLE



S 1192.39

zinc die cast
0.228 kg

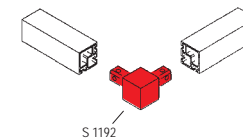
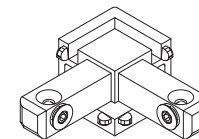

32 X 32 MM

Extrusions in general

KNUCKLE



S 1190.39

zinc die cast
0.266 kg

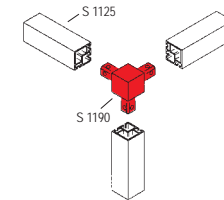
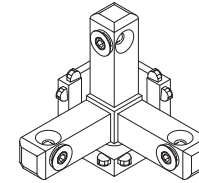

32 X 16 MM

Extrusions in general

BEAM EXTRUSION for bracing groove depth 7 mm



Z 308.01.11

aluminium
tension lock Z 961/13 can be mounted, groove depth 7 mm, 5000 mm long
2.68 kg

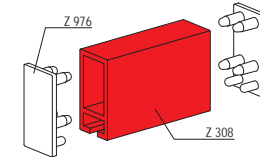
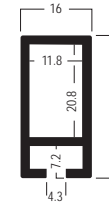

END CAP



Z 976.35

plastic
for extrusion Z 308
0.002 kg

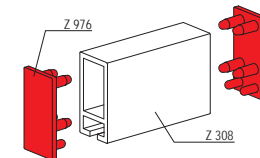
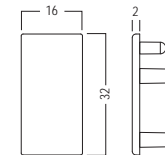

37 X 16 MM

Extrusions in general

BEAM EXTRUSION

37 mm
groove depth 10 mm

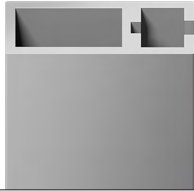

Z 310.01.11

aluminium
tension lock Z 961/13 can be mounted, groove depth 10 mm, 5000 mm long
2.962 kg

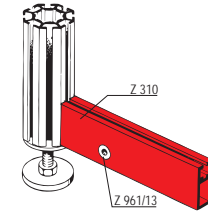
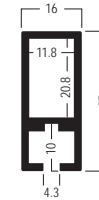

END CAP



Z 974.30.35

plastic
for Z 310
0.002 kg

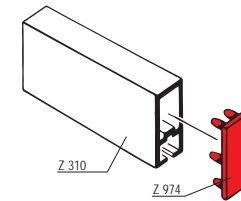
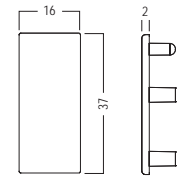

40 X 16 MM

Extrusions in general

BEAM EXTRUSION

for bracing
40 x 16 mm



Z 4400.01

aluminium
tension lock Z 961/13 can be mounted, 5000 mm long
3.2 kg

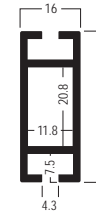

BEAM EXTRUSION

40 mm
5000 mm long



Z 4401.01

aluminium
tension lock Z 961/13 can be mounted
3.38 kg

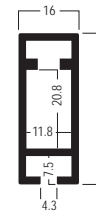

END CAP



Z 4430.35

plastic
for beam extrusions Z 4100, Z 4300, Z 4400, Z 4401
0.002 kg

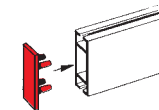
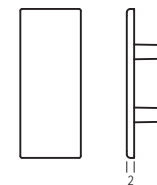

40 X 32 MM

Extrusions in general

BEAM EXTRUSION

40 mm
5000 mm long

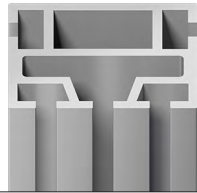

Z 2100.01

aluminium
tension lock Z 961/13 can be mounted
5.99 kg

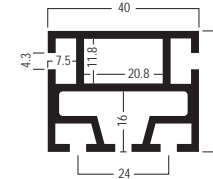

BEAM EXTRUSION

40 mm
5000 mm long

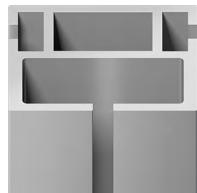

Z 2105.01

aluminium
tension lock Z 961/13 can be mounted
5.56 kg

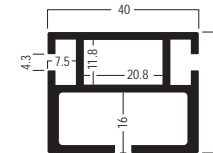

END PLATE

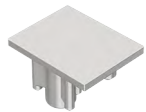

Z 2131.39

zinc die cast
for beam extrusions Z 2100, Z 2105
0.038 kg

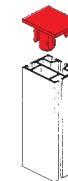
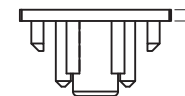

50 X 16 MM

Extrusions in general

BEAM EXTRUSION
for 2 tension locks
50 mm



Z 402.01.11

aluminium
mounting 2 tension locks Z 961/13 one on top of the other,
5000 mm long
3.76 kg

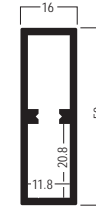

BEAM EXTRUSION
50 mm
groove depth 10 mm



Z 400.01.11

aluminium
tension lock Z 961/13 can be mounted, groove depth 10
mm, 5000 mm long
4.39 kg

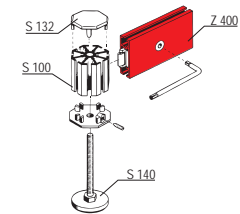
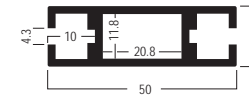

END CAP



Z 975.35

plastic
for Z 400, Z 402 and Z 460
0.003 kg

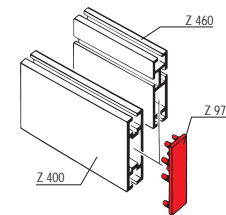
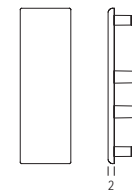

70 X 16 MM

Extrusions in general

BEAM EXTRUSION

70 mm
groove depth 10 mm

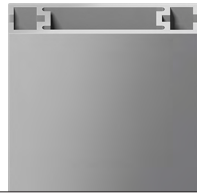

Z 110.01.11

aluminium
groove depth 10 mm
5,42 kg

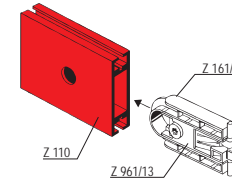

! Attention: for mounting tension lock Z 961/13 the adaptor Z 161/A is needed

END CAP



Z 175.35

plastic
for Z 110 and Z 160
0,003 kg

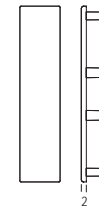

TECHNICAL INFORMATION

TI-M-3.2	155
Supporting capacity values	
TI-M-3.3	156
Supporting capacity values	
TI-M-3.4	157
Supporting capacity values	
TI-M-3.5	158
Supporting capacity values	
TI-M-3.6.1	159
Supporting capacity values	
TI-M-9.0	160
Extension of upright and beam extrusions	

Supporting capacity values

The indicated values apply provided that the construction of the beams prevents them from twisting. Proof must be produced for the flexural buckling and torsional-flexural buckling values separately.

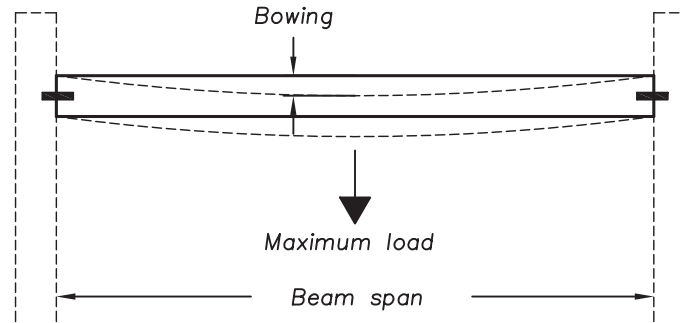
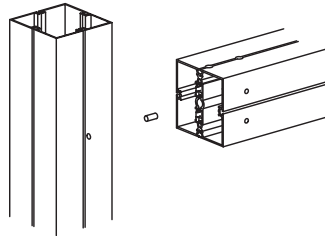

With beam supports higher load capacity is achieved which results in "more safety"

maximum possible loads (in addition to dead weight) and the resulting calculated bowing of beams with maximum permissible bowing of 1/300 of the span.

xxx (values which are underlined)=the maximum admissible bearing load is decisive

		Beam spans (m) :														
		1.0	1.5	2.0	2.5	3.0	3.5	4.0	4.5	5.0	5.5	6.0	6.5	7.0		
Each side 2x tension locks and 1x support beam	 M 225	Single load in beam center (kg):		<u>469</u>	<u>467</u>	<u>465</u>	<u>463</u>	<u>370</u>	269	202	156	123	98	78	63	51
		uniformly distributed load (kg/m):		<u>469</u>	<u>311</u>	<u>232</u>	<u>185</u>	<u>153</u>	122	80	55	39	28	21	15	11
		bowing (cm):		0.00	0.10	0.23	0.45	0.78	1.16	1.32	1.50	1.65	1.82	2.00	2.17	2.33
Each side 1x tension lock and 1x support beam	 M 1020	(kg):		472	229	127	80	87	61	45	33	25	18	13	---	---
		(kg/m):		472	244	102	51	36	28	18	12	8	5	3	---	---
		(cm):		0.12	0.32	0.42	0.53	0.81	1.15	1.33	1.50	1.67	1.83	2.00	---	---
Each side 2x tension locks and 1x support beam	 M 205 M 235* M 245	(kg):		470	468	466	340	233	169	126	97	75	59	47	37	29
		(kg/m):		470	312	233	186	124	77	50	34	24	17	12	9	6
		(cm):		0.05	0.15	0.37	0.72	1.00	1.17	1.32	1.48	1.66	1.81	1.93	2.14	2.19
Each side 1x tension lock and 1x support beam	 M 1220* M 1222	(kg):		472	229	127	80	54	38	27	20	14	10	7	4.2	---
		(kg/m):		472	244	102	51	28	17	11	7	4.5	3	1.8	1	---
		(cm):		0.19	0.50	0.67	0.83	0.97	1.14	1.33	1.48	1.62	1.81	1.94	2.10	---

* = average value relevant for data collection

Supporting capacity values

The indicated values apply provided that the construction of the beams prevents them from twisting. Proof must be produced for the flexural buckling and torsional-flexural buckling values separately.

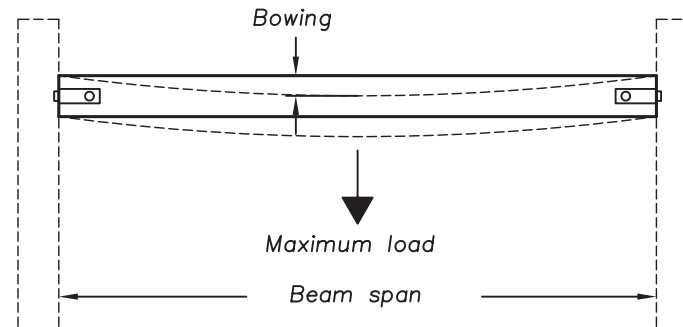
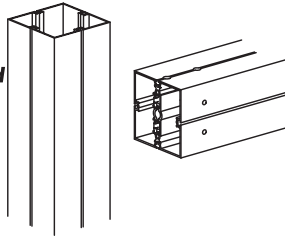

maximum possible loads (in addition to dead weight) and the resulting calculated bowing of beams with maximum permissible bowing of 1/300 of the span.

xxx (values which are underlined)=the maximum admissible bearing load is decisive

				Beam spans (m) :												
				1.0	1.5	2.0	2.5	3.0	3.5	4.0	4.5	5.0	5.5	6.0	6.5	7.0
Each side 2x tension locks		M 225	Single load in beam center (kg):	<u>239</u>	<u>237</u>	<u>235</u>	<u>233</u>	<u>231</u>	<u>222</u>	<u>202</u>	<u>156</u>	123	98	78	63	51
			uniformly distributed load (kg/m):	<u>239</u>	<u>158</u>	<u>117</u>	<u>93</u>	<u>77</u>	<u>65</u>	<u>56</u>	<u>50</u>	39	28	21	15	11
			bowing (cm):	0.01	0.05	0.12	0.23	0.40	0.64	0.96	1.36	1.65	1.82	2.00	2.17	2.33
Each side 1x tension lock		M 1020	(kg):	<u>120</u>	<u>117</u>	<u>115</u>	<u>110</u>	87	61	45	33	25	18	13	---	---
			(kg/m):	<u>120</u>	<u>79</u>	<u>59</u>	<u>46</u>	36	28	18	12	8	5	3	---	---
			(cm):	0.03	0.10	0.25	0.48	0.81	1.15	1.33	1.50	1.67	1.83	2.00	---	---
Each side 2x tension locks		M 205 M 235* M 245	(kg):	<u>240</u>	<u>237</u>	<u>236</u>	<u>235</u>	<u>230</u>	<u>169</u>	126	97	75	59	47	37	29
			(kg/m):	<u>240</u>	<u>159</u>	<u>118</u>	<u>94</u>	<u>77</u>	<u>66</u>	50	34	24	17	12	9	6
			(cm):	0.02	0.08	0.19	0.37	0.63	1.00	1.32	1.48	1.66	1.81	1.93	2.14	2.19
Each side 1x tension lock		M 1220* M 1222	(kg):	<u>120</u>	<u>117</u>	<u>115</u>	<u>110</u>	54	38	27	20	14	10	7	4.2	---
			(kg/m):	<u>120</u>	<u>79</u>	<u>59</u>	<u>46</u>	28	17	11	7	4.5	3	1.8	1	---
			(cm):	0.05	0.16	0.39	0.75	0.97	1.14	1.33	1.48	1.62	1.81	1.94	2.10	---

* = average value relevant for data collection

Supporting capacity values



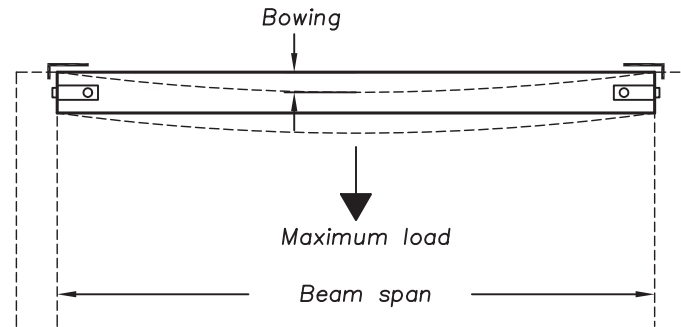
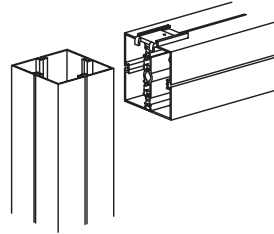



The indicated values apply provided that the construction of the beams prevents them from twisting. Proof must be produced for the flexural buckling and torsional-flexural buckling values separately.

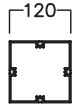

maximum possible loads (in addition to dead weight) and the resulting calculated bowing of beams with maximum permissible bowing of 1/300 of the span.

With beam supports higher load capacity is achieved which results in "more safety"

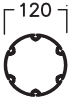
xxx (values which are underlined)=the maximum admissible bearing load is decisive

		Beam spans (m) :															
		1.0	1.5	2.0	2.5	3.0	3.5	4.0	4.5	5.0	5.5	6.0	6.5	7.0			
Each side 2x tension locks and 1x support beam	 M 225	Single load in beam center (kg):	<u>2131</u>	<u>2128</u>	<u>846</u>	<u>538</u>	<u>370</u>	269	202	156	123	98	78	63	51		
		uniformly distributed load (kg/m):	<u>2131</u>	<u>1419</u>	<u>677</u>	<u>344</u>	<u>197</u>	122	80	55	39	28	21	15	11		
		bowing (cm):	<u>0.13</u>	<u>0.44</u>	<u>0.67</u>	<u>0.83</u>	<u>1.00</u>	1.16	1.32	1.50	1.65	1.82	2.00	2.17	2.33		
Each side 1x tension lock and 1x support beam	 M 1020	(kg):	<u>519</u>	229	127	80	87	61	45	33	25	18	13	---	---		
		(kg/m):	<u>831</u>	244	102	51	36	28	18	12	8	5	3	---	---		
		(cm):	<u>0.33</u>	0.32	0.42	0.53	0.81	1.15	1.33	1.50	1.67	1.83	2.00	---	---		
Each side 2x tension locks and 1x support beam	 M 205	 M 235*	 M 245	(kg):	<u>2133</u>	<u>958</u>	<u>536</u>	<u>340</u>	233	169	126	97	75	59	47	37	29
				(kg/m):	<u>2133</u>	<u>1021</u>	<u>429</u>	<u>218</u>	124	77	50	34	24	17	12	9	6
				(cm):	<u>0.21</u>	<u>0.50</u>	<u>0.67</u>	<u>0.83</u>	1.00	1.17	1.32	1.48	1.66	1.81	1.93	2.14	2.19
Each side 1x tension lock and 1x support beam	 M 1220*	 M 1222	(kg):	<u>519</u>	229	127	80	54	38	27	20	14	10	7	4.2	---	
			(kg/m):	<u>831</u>	244	102	51	28	17	11	7	4.5	3	1.8	1	---	
			(cm):	<u>0.33</u>	0.50	0.67	0.83	0.97	1.14	1.33	1.48	1.62	1.81	1.94	2.10	---	

* = average value relevant for data collection

Supporting capacity values

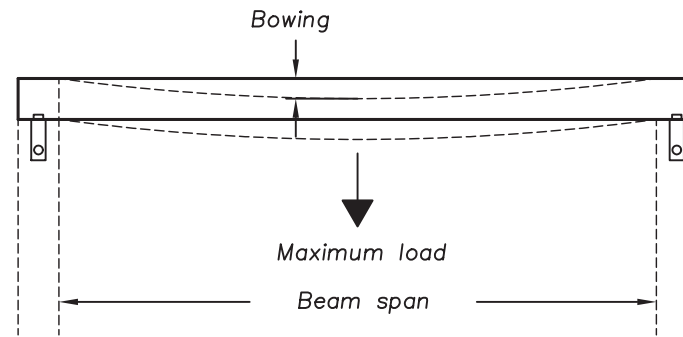
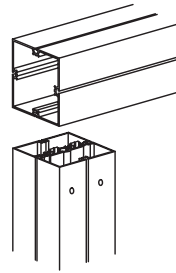

The indicated values apply provided that the construction of the beams prevents them from twisting. Proof must be produced for the flexural buckling and torsional-flexural buckling values separately.



maximum possible loads (in addition to dead weight) and the resulting calculated bowing of beams with maximum permissible bowing of 1/300 of the span.

xxx (values which are underlined)=the maximum admissible bearing load is decisive

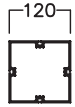
value marked with ■ = the area of shearing force is decisive

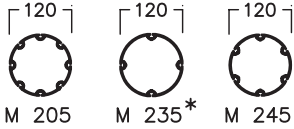
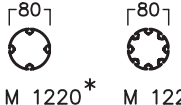
		Beam spans (m) :													
		1.0	1.5	2.0	2.5	3.0	3.5	4.0	4.5	5.0	5.5	6.0	6.5	7.0	
Each side 1x tension lock in vertical position	 M 225	Single load in beam center (kg):	■ 3184	2416	846	538	370	269	202	156	123	98	78	63	51
		uniformly distributed load (kg/m):	■ 3184	1611	677	344	197	122	80	55	39	28	21	15	11
		bowing (cm):	0.20	0.50	0.67	0.83	1.00	1.16	1.32	1.50	1.65	1.82	2.00	2.17	2.33
Each side 1x tension lock in vertical position	 M 1020	(kg):	822	364	203	128	87	61	45	33	25	18	13	---	---
		(kg/m):	1316	388	162	51	36	28	18	12	8	5	3	---	---
		(cm):	0.33	0.32	0.42	0.53	0.81	1.15	1.33	1.50	1.67	1.83	2.00	---	---
Each side 1x tension lock in vertical position	 M 205 M 235* M 245	(kg):	<u>2133</u>	<u>958</u>	<u>536</u>	<u>340</u>	233	169	126	97	75	59	47	37	29
		(kg/m):	<u>2133</u>	<u>1021</u>	<u>429</u>	<u>218</u>	124	77	50	34	24	17	12	9	6
		(cm):	0.21	0.50	0.67	0.83	1.00	1.17	1.32	1.48	1.66	1.81	1.93	2.14	2.19
Each side 1x tension lock in vertical position	 M 1220* M 1222	(kg):	519	229	127	80	54	38	27	20	14	10	7	4.2	---
		(kg/m):	<u>831</u>	244	102	51	28	17	11	7	4.5	3	1.8	1	---
		(cm):	0.33	0.50	0.67	0.83	0.97	1.14	1.33	1.48	1.62	1.81	1.94	2.10	---

* = average value relevant for data collection

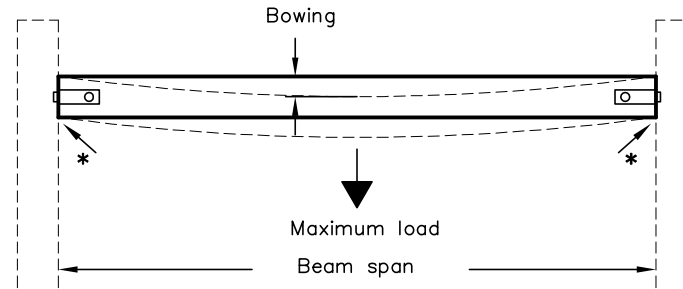
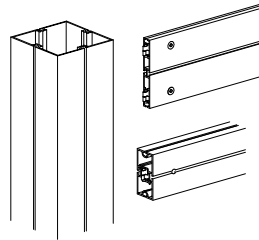

*** = Security advice :**
A total beam load of more than 70 kg requires one beam retainer on each side



maximum possible loads (in addition to dead weight) and the resulting calculated bowing of beams with maximum permissible bowing of 1/300 of the span.

(transverse reinforcements are necessary)

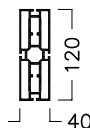
xxx (values which are underlined)=the maximum admissible bearing load is decisive

		Beam spans (m) :												
		1.0	1.5	2.0	2.5	3.0	3.5	4.0	4.5	5.0	5.5	6.0	6.5	7.0
Each side 2x tension locks M 1030 	Single load in beam center (kg):	<u>170</u>	<u>168</u>	<u>166</u>	<u>164</u>	146	105	78.2	60	46	36	27.7	---	---
	uniformly distributed load (kg/m):	<u>170</u>	<u>112</u>	<u>83</u>	<u>66</u>	<u>54</u>	<u>46</u>	39.1	27	18	13	9.2	---	---
	bowing (cm):	0.04	0.14	0.33	0.65	1.00	1.17	1.33	1.50	1.66	1.83	2.00	---	---
Each side 1x tension lock M 1091 	Single load in beam center (kg):	<u>170</u>	169	116	72	49	34	24	17.5	12.4	8.5	5.4	---	---
	uniformly distributed load (kg/m):	<u>170</u>	<u>113</u>	<u>84</u>	58	32	20	12	7.8	5.0	3.1	1.8	---	---
	bowing (cm):	0.12	0.41	0.66	0.83	1.00	1.17	1.33	1.50	1.66	1.83	2.00	---	---
Each side 1x tension lock M 1082 	Single load in beam center (kg):	<u>171</u>	99	55	34	22	15.1	10.3	6.8	4.2	2.2	0.5	---	---
	uniformly distributed load (kg/m):	<u>171</u>	<u>113</u>	55	27	15	8.6	5.1	3.0	1.7	0.8	0.2	---	---
	bowing (cm):	0.13	0.5	0.66	0.83	1.00	1.17	1.33	1.50	1.66	1.83	2.00	---	---

Extension of upright and beam extrusions
(Maxima light - program)

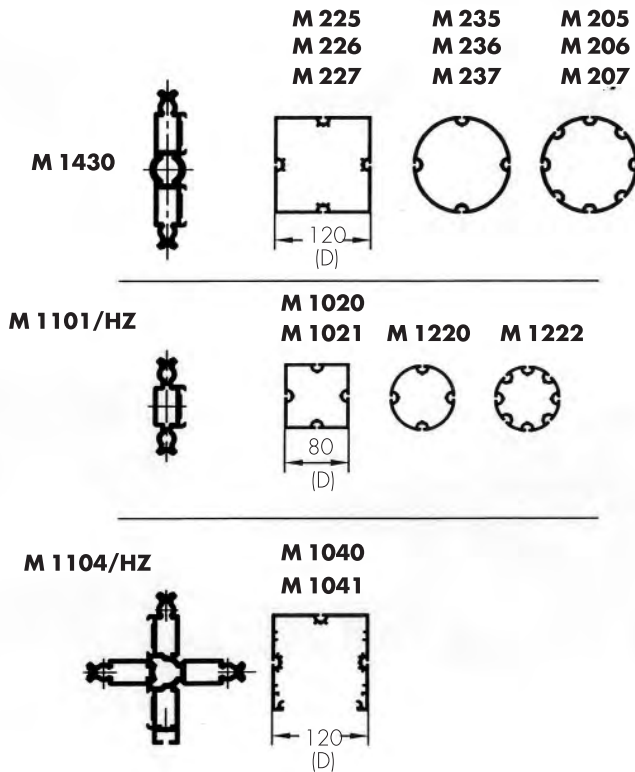

L = Profile extension

L = 250 bis 990 mm

$X_1 = 2 \times D$

L = 1000 bis 3000 mm

$X_1 = 3 \times D$

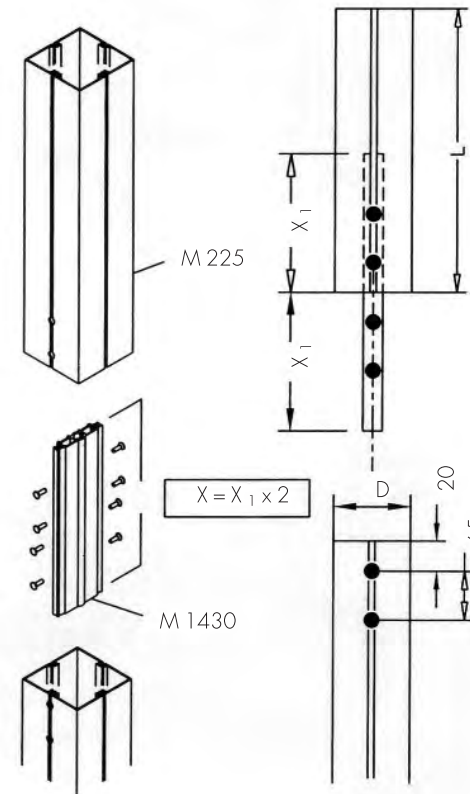

Important: Extensions of beam extrusions must be re-checked according to load.

HAMMER HEAD SCREW

Accessories / Tools

HAMMERHEAD SCREW

M8 x 19



M 1472.37

steel
for system groove 4.3 mm
0.024 kg

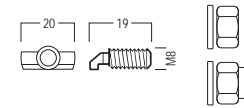

HAMMERHEAD SCREW

M8 x 24



M 1473.37

steel
for system groove 4.3 mm
0.025 kg

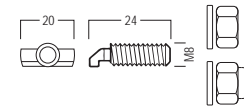

HAMMERHEAD SCREW

M10 x 23



M 812.37

steel
for system groove 4.3 mm
0.041 kg

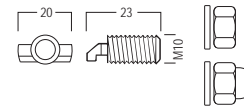

HAMMER HEAD SCREW

Accessories / Tools

HAMMERHEAD SCREW combination cross recess



E 203.38

steel

sleeve E 209/Hü with combination cross recess, for system groove 4.3 mm
0.011 kg

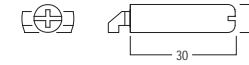

! Attention: maximum load capacity 35 kg

HAMMERHEAD SCREW elongated slot and allen screw 4 mm



E 205.38

steel

incl. plastic ring E 201, sleeve E 204, 10 mm dia., elongated slot and allen screw 4 mm, for system groove 4.3 mm
0.012 kg

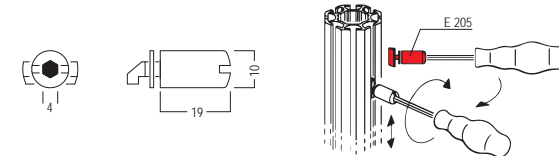

! Attention: maximum load capacity 35 kg

HAMMERHEAD SCREW combination cross-slot



E 210.38

steel

sleeve E 210/Hü with combination cross-slot, for system groove 4.3 mm
0.007 kg

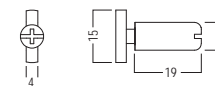

! Attention: maximum load capacity 35 kg

HAMMER HEAD SCREW

Accessories / Tools

HAMMERHEAD SCREW
for glass shelf
hexagon socket 4 mm



E 210/M8.30.35

steel/plastic
with threaded sleeve M8, hexagon socket 4 mm and plastic sleeve for glass shelf, for system groove 4.3 mm
0.006 kg

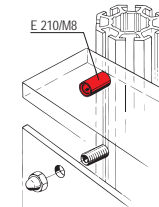
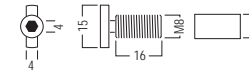

! Attention: maximum load capacity 35 kg

CONNECTORS

Accessories / Tools

INTERNAL CORNER CONNECTOR

Z 966B/V.00

zinc die cast incl. 2 countersunk screws E 111 and E 111/20 for extrusions with lock chamber 21 x 12 mm adjustable from 22,5° to 337,5°
0.13 kg

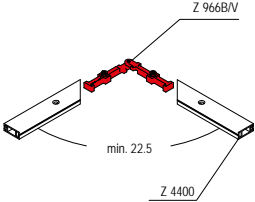
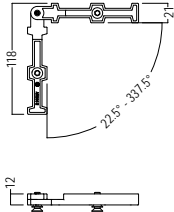

INTERNAL CORNER CONNECTOR for extrusion with lock chamber 21 x 12 mm

Z 966.00

aluminium
with 2 x E 111 and E 111/20 countersunk screw
0.082 kg

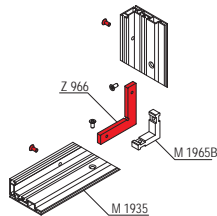
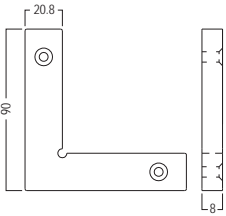

INTERNAL CONNECTOR straight

Z 967.00

aluminium
incl. 1 x set screw Z 967/20 (M6), 2 x hex-star screw E 111/m (M6), 2 x countersunk screw M 1102/20 (M6) and 2 x washer Z 185, for extrusions with lock chamber 21 x 12 mm and hole Ø 13 mm
0.128 kg

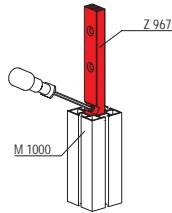
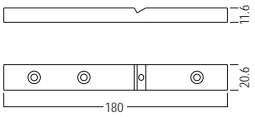

INTERNAL CONNECTOR

straight
for extrusions 32 mm



S 1155.00

aluminium

incl. 2 countersunk screws E111/m (M6), for quarter-round, square and triangular extrusions 32 mm
0.049 kg

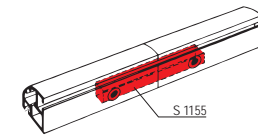
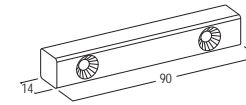

INTERNAL CORNER CONNECTOR

for extrusions 32 mm



S 1150.00

aluminium

incl. 2 countersunk screws E111/m (M6), suitable for internal and external miters, for quarter-round, square and triangular extrusions 32 mm
0.031 kg

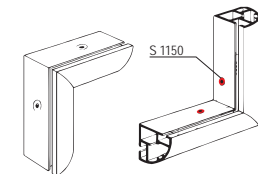
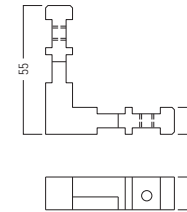

CLIP



S 1154.44

stainless steel

for connection of 2 aluminium extrusions placed side by side
0.002 kg

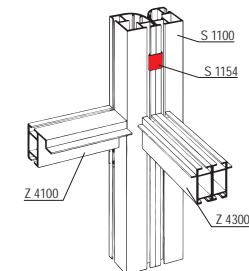
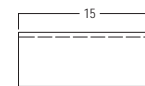
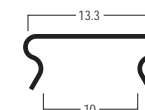

EXTRUSION CONNECTOR for system groove 5000 mm long



E 438.30

plastic, semi-hard

for connection of 2 aluminium extrusions in parallel alignment, suitable for extrusions with a narrow mounting chamber (8.7 mm min.)
0.277 kg

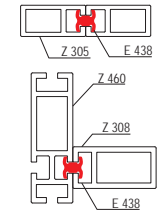

TENSION LOCKS

Accessories / Tools

TENSION LOCK

13 mm
21 × 12 mm



Z 951/13.00

zinc die cast/steel
for all beam extrusions with lock chamber 21 × 12 mm and
key hole aperture
0.052 kg

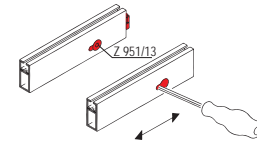
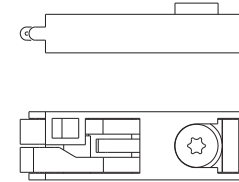

TENSION LOCK

8 mm
21 × 12 mm



Z 951/8.00

zinc die cast/steel
for all upright-, round- and square extrusions with lock
chamber 21 x 12 mm and key hole aperture
0.054 kg

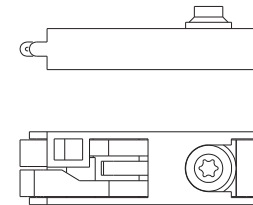

TENSION LOCK

13 mm
21 × 12 mm



Z 961/13.00

zinc die cast/steel
for all beam extrusions with lock chamber 21 x 12 mm as
well as in conjunction with adaptor Z 161/A for beam
extrusions with lock chamber 39 x 12 mm
0.052 kg

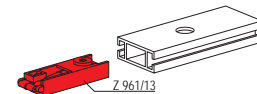
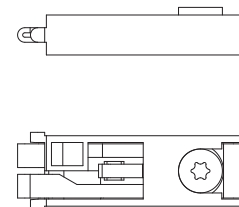

TENSION LOCKS

Accessories / Tools

ADAPTOR

for Z 961/13
lock chamber 39 × 12 mm



Z 161/A.90

plastic
for mounting tension locks Z 961/13 in beam extrusions
with lock chamber 39 × 12 mm
0.009 kg

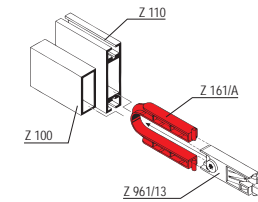
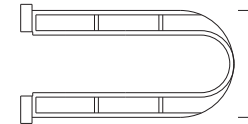

TENSION LOCK

8 mm
21 x 12 mm

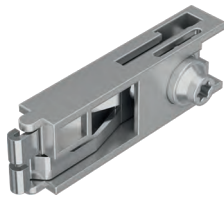

Z 961/8.00

zinc die cast/steel
for all beam extrusions with lock chamber 21 × 12 mm
0.054 kg

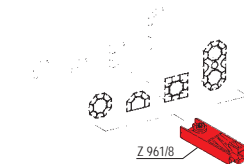
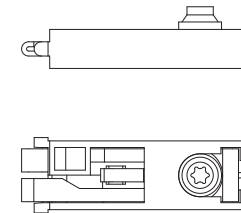

CLAMPING ELEMENTS

Accessories / Tools

CLAMPING ELEMENT
variable in angle
max. 15°



Z 942.37

steel
for all beam extrusions with lock chamber 21 x 12 mm,
variable in angle, max. 15°
0.066 kg

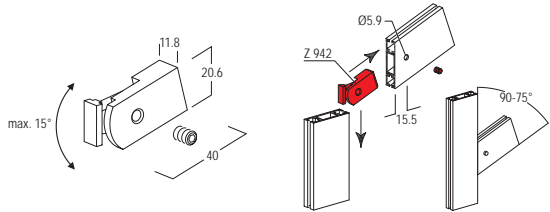

CLAMPING ELEMENT
operating through
system groove



Z 940.37

steel
for all beam extrusions with lock chambers 21 x 12 mm,
operating through system groove
0.089 kg

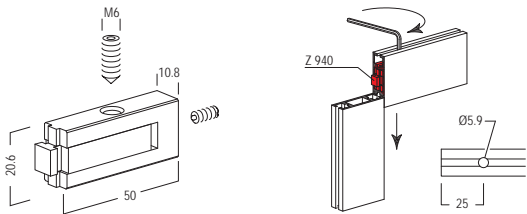

CLAMPING ELEMENT
variable in angle
max. 15°



Z 943.37

steel/plastic
for all extrusions with lock chamber 21 x 12 mm, variable
in angle, max. 15°
0.073 kg

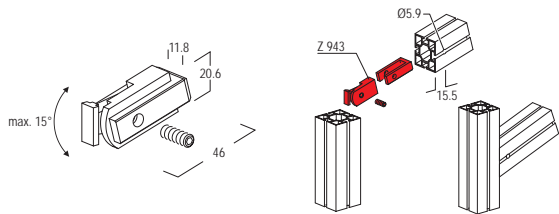

TOOLS

Accessories / Tools

TOOL SET



E 13.90

steel/plastic
0.059 kg



SCREWDRIVER hex-star T30



E 14.90

steel/plastic
wrench
0.039 kg

SCREWDRIVER hex-star T30



E 113.90

steel/plastic
0.122 kg

TOOLS

Accessories / Tools

TOOL SET



E 114.90

steel
hex-star T30
0.02 kg

RATCHET



E 115.90

steel
1/4"
0.11 kg

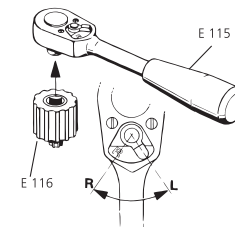

TOOL SET



E 116.90

plastic/steel for E 115, hex-star T30
0.019 kg

TOOLS

Accessories / Tools

TOOL SET



E 116/42.90

steel
hex-star T30 , for Z 961/8
0.021 kg

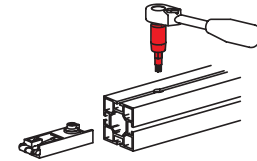

HEXAGON WRENCH



E 117.90

steel
0.04 kg

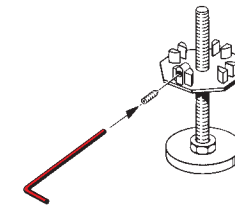

SCREWDRIVER

A/F 3 mm for setscrew E 111/g



E 130.90

plastic/steel 1 wrench, 1 ball head screw driver,
0.046 kg

TOOLS

Accessories / Tools

TOOL SET

A/F 2 mm for setscrew M4



E 131.90

steel/plastic
0.019 kg

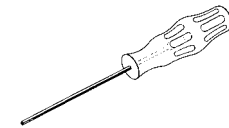

SCREWDRIVER

A/F 4 mm for E 210/M8



E 132.90

plastic/steel
0.032 kg

TOOL SET



M 945.90

steel
hex-star T30, 1/4"
0.024 kg

TOOLS

Accessories / Tools

TOOL SET hex-star T30



M 951.90

steel/plastic
0.074 kg

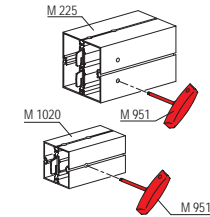
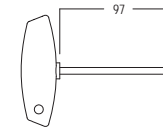

TOOL SET



C 901.90

none
steel extension for ratchet, 50 mm long coupling adapter
socket wrench for ratchet bits, hex-star 30, 40 mm long
bits, SW 5, 25 mm long hex-star head screwdriver, T30
allen screwdriver, SW 2 magnetic screw holder
0.584 kg

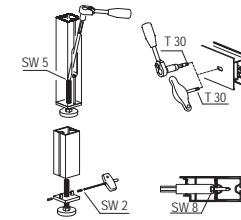

CLEANING EMULSION



E 124.90

500 ml bottle for powder-coated surfaces and plastic
extrusions
1.067 kg



DRILLING jig



BS 4.90

steel

with drill guide bush ZBS 100 (8 mm) and distance block ZBS 140 for 8 mm system drilling for fitting tension locks Z 961/8 in upright extrusions drilling tools must be ordered separately
0.612 kg

DRILLING jig



BS 6.90

steel

with drill guide bush ZBS 102 (13 mm) and 4 spacer pins ZBS 141 for tension lock chamber 21 x 12 mm and 39 x 12 mm for 13 mm system drilling for fitting tension locks Z 961/13 drilling tools must be ordered separately
0.435 kg

GLASS PANEL RETAINER

for glass
4-8 mm

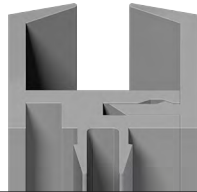

E 420.30.33.35

plastic
for 4 - 8 mm panels
0,83 kg

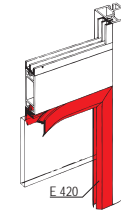
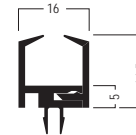

DOOR STOPPING EXTRUSION

for hinged doors
5000 mm long



E 430.30.35

plastic, semi-hard
with soft rubber lip insert for hinged wooden or glass doors
0,37 kg

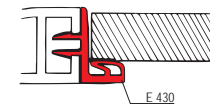
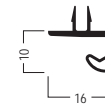

GLASS PANEL RETAINER

for glass
4-6 mm



E 424.30.35

plastic
for 4 - 6 mm panels
0,45 kg

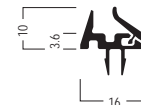

GLASS PANEL RETAINER

for E 441
5000 mm long

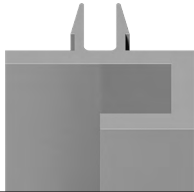

E 440.30.35

plastic, semi-hard
also useable as door stopper extrusion in combination with E 441
0.47 kg

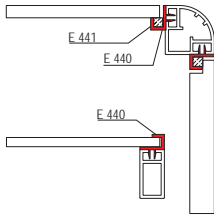
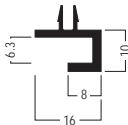

RUBBER SPONGE

for E 440
50000 mm long



E 441.35

rubber
for use with E 440 only, for glass support and door stop
1 kg

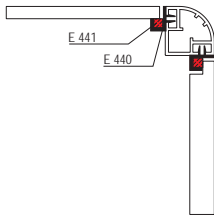

SUPPORTING EDGE

5000 mm long

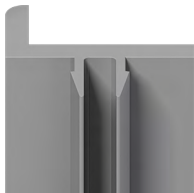

E 442.30.35

plastic, semi-hard
0.4 kg

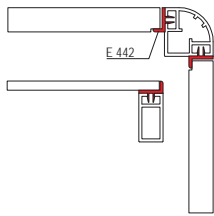
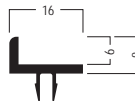

ANTI RATTLE
for hollow chambers
from 5,4 x 12 mm

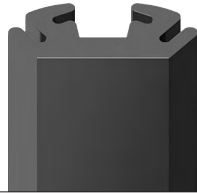

E 444.33

rubber
for mounting glass in the system groove, glass thickness 4 mm, insertable in all hollow chambers from 5.4 x 12 mm
2.018 kg

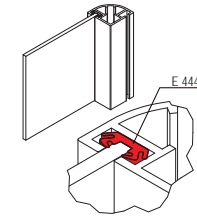

ANTI RATTLE
for S 1129/S 1303/
S 1310



E 445.33

rubber
for mounting glass in the system groove, glass thickness 4 mm, insertable in extrusions S 1129, S 1303 and S 1310
3.5 kg



ANTI RATTLE
for M 1620/M 1622
M 1625/M 1629

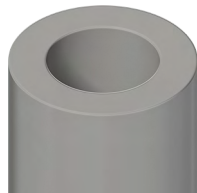

M 1643.51

Silicone
for mounting glass in the system groove, glass thickness 4 mm, insertable in extrusions M 1620, M 1622, M 1625, M 1629
0.4 kg

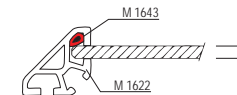

ANTI RATTLE
für M 1600/M 1606
50000 mm long

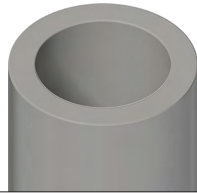

M 1644.51

Silicone
for mounting glass in the system groove, glass thickness 4 mm, insertable in extrusions M 1600, M 1606
1.177 kg

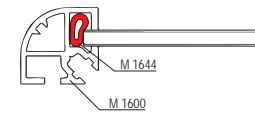

CLIP



E 470/C.30

plastic
to put into extrusion E 470/N, E 471/N recommendation:
4 pieces / running meter for extrusion C 722,
2 pieces / running meter for extrusion W 910

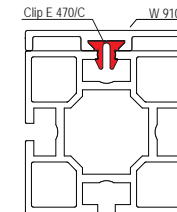
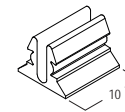

DOOR SLIDE FITTING
for E 472
5000 mm long



E 471/N.01

aluminium
for runner frame extrusion E 472
1.61 kg

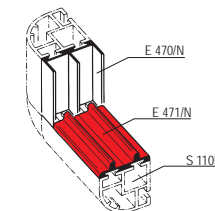
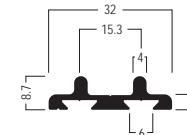

Attention: plastic clip E 470/C to be ordered separately

RUNNER FRAME EXTRUSION

5000 mm long



E 472.01

aluminium
for glass thickness 5 and 6 mm
1.74 kg



OTHER ACCESSORIES

Accessories / Tools

SELF TAPPING SCREW

3,5 x 16 mm



C 693-3516.37

steel
0.002 kg



SELF TAPPING SCREW

4,8 x 38 mm



C 693-4838.37

steel
0.002 kg



SELF TAPPING SCREW

2,9 x 13 mm



C 695-2913.37

steel
0.002 kg



OTHER ACCESSORIES

Accessories / Tools

SELF TAPPING SCREW

3,5 x 13 mm



C 695-3513.37

steel
0.002 kg



SELF TAPPING SCREW

3,5 x 16 mm



C 695-3516.37

steel
0.002 kg



SELF TAPPING SCREW

4,8 x 70 mm



C 697-4870.37

steel, zinc plated
drilling screw with hexagonal head with collar
0.004 kg



OTHER ACCESSORIES

Accessories / Tools

PAINT STICK
RAL 9010 white



C 968.90

none
0.03 kg

ADHESIVE



C 971.30.90

Polymer
0.48 kg

SEALANT



C 972.30

Polymer
0.51 kg

OTHER ACCESSORIES

Accessories / Tools

ADJUSTABLE FOOT



Q 152.37

steel with thread M10
0.088 kg

THREADED PLATE for system groove



M 1078.37

steel
with antislipping device, female thread M4
0.003 kg

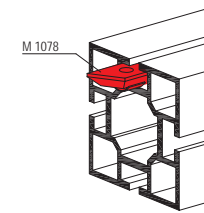

FIXING ANGLE

M 1077.37

steel incl. hammerhead screw M 1470
0.042 kg

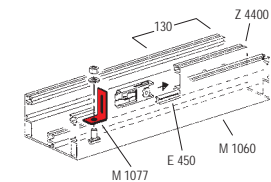
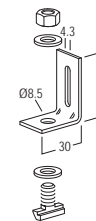

OTHER ACCESSORIES

Accessories / Tools

DOOR HINGE for hinged doors

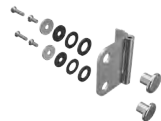

E 290.01

aluminium
incl. mounting parts and distance washers, for hinged glass and wooden doors 5, 6, 8, 16, 19 mm
0.08 kg

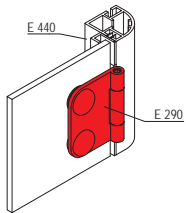
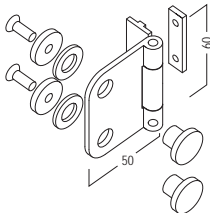

COVER EXTRUSION for system groove 5000 mm long

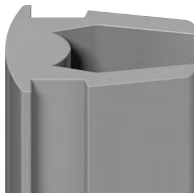

E 455.30.33.35

plastic, semi-hard
for system groove 4.3 mm
0.12 kg

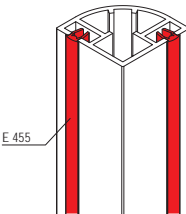

CABLE RETAINING small 5000 mm long



E 460.30.35

plastic, semi-hard
for mounting of cables to system groove
0.73 kg

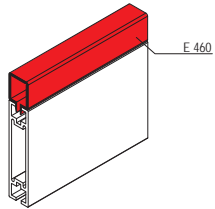
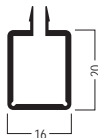

OTHER ACCESSORIES

Accessories / Tools

GRAB HANDLE



C 940.90

plastic
black
0.5 kg

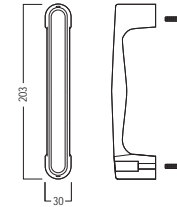

PANEL LATCHES



C 975.37

steel
0.088 kg

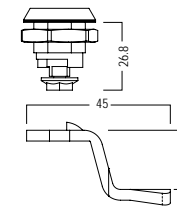

PUSH TO CLOSE LATCH



C 952.39

plastic
chrome plated pull to open design
0.062 kg

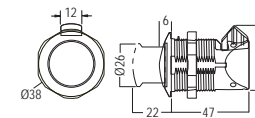

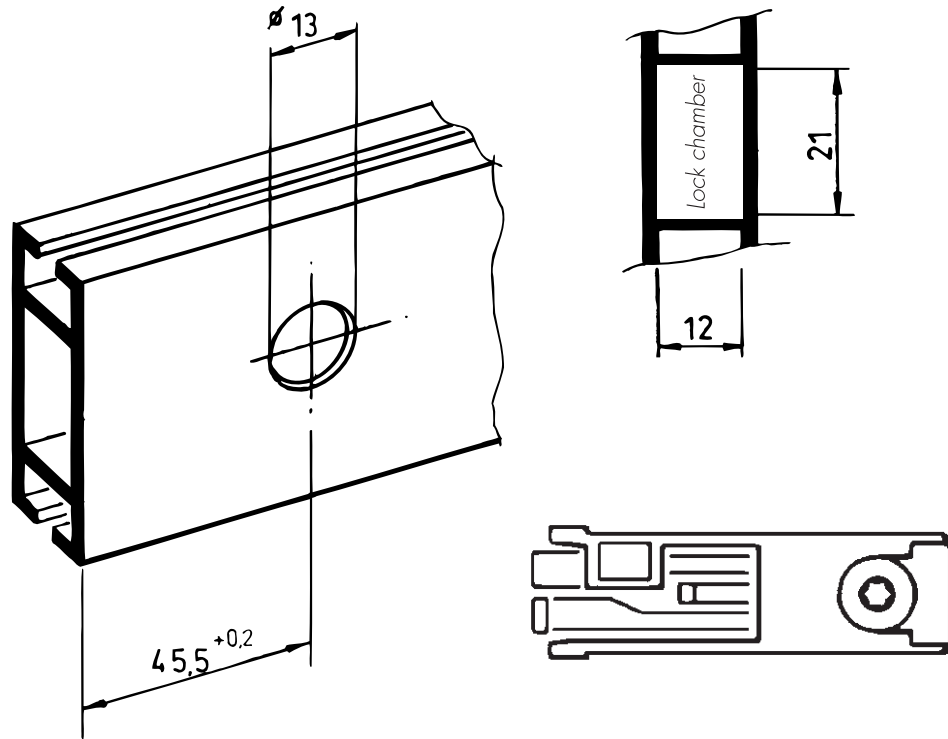

For punching at both ends minimum length 125 mm

Press eccentric head;
insert in beam till it locks

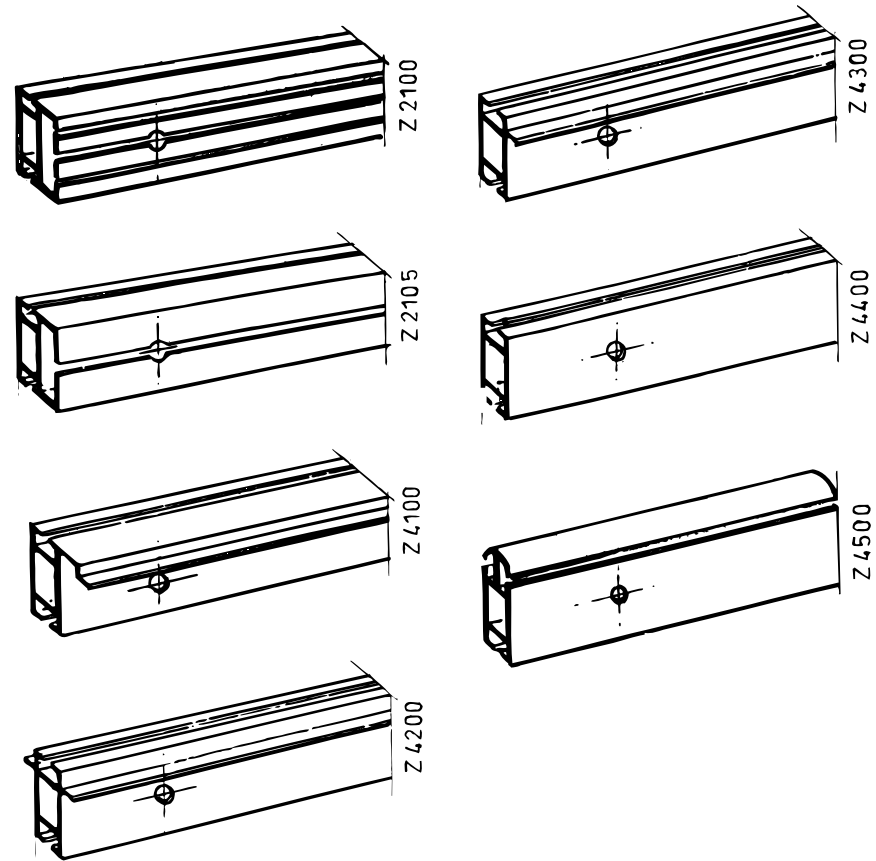
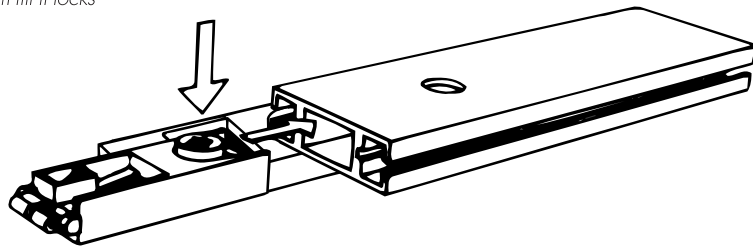

Important:
For exact punching use drilling jig BS 6 at choice with distance piece
(see catalogue "Tools for Mechanical Treatment")

**OCTANORM Germany
Head Office**

Raiffeisenstraße 39
70794 Filderstadt
T. +49 711 77003 0
F. +49 711 77003 53
info@octanorm.de
www.octanorm.com

EUROPE

OCTANORM® Adria
T. +386 590 56 301
www.octanormadria.com

OCTANORM® Belgium
T. +32 (0)2 345 6031
www.octanorm.be

OCTANORM® Espana
T. +34 930 019 424
www.octanorm.es

OCTANORM® Hellas
T. +30 2310 7965 21
www.octanorm.gr

OCTANORM® Italia
T. +39 2 9645 1966
www.octanorm.it

OCTANORM® Nederland
T. +31 50 309 5133
www.octanorm.nl

OCTANORM® Nordic
T. +46 8 621 65 00
www.octanorm.se

OCTANORM® Polska
T. +48 22 773 03 50
www.octanorm.pl

OCTANORM® Russia
T. +7 495 565 7920
www.octanorm.ru

OCTANORM® UK
T. +44 20 85 452 945
www.octanorm.co.uk

NORTH AMERICA

OCTANORM® North America
T. +1 770 7 32 1520
www.octanormna.com

CENTRAL AMERICA

OCTANORM® México
T. +52 55 5804 6325
www.octanorm.com.mx

SOUTH AMERICA

OCTANORM® Argentina
T. +54 11 4312 4000
www.octanorm.com.ar

AFRICA

OCTANORM® South Africa
T. +27 11 433 2010
http://www.octanorm.co.za

MIDDLE EAST

AUSTRALIA / SOUTH PACIFIC

OCTANORM® Australia
T. +61 3 8773 8550
www.octanorm.com.au

ASIA

OCTANORM® China
T. +86 5126 283 3336
www.octanorm.cn

OCTANORM® Japan
T. +81 45 511 8144
www.octanorm.co.jp